

LEAVE TYP 01

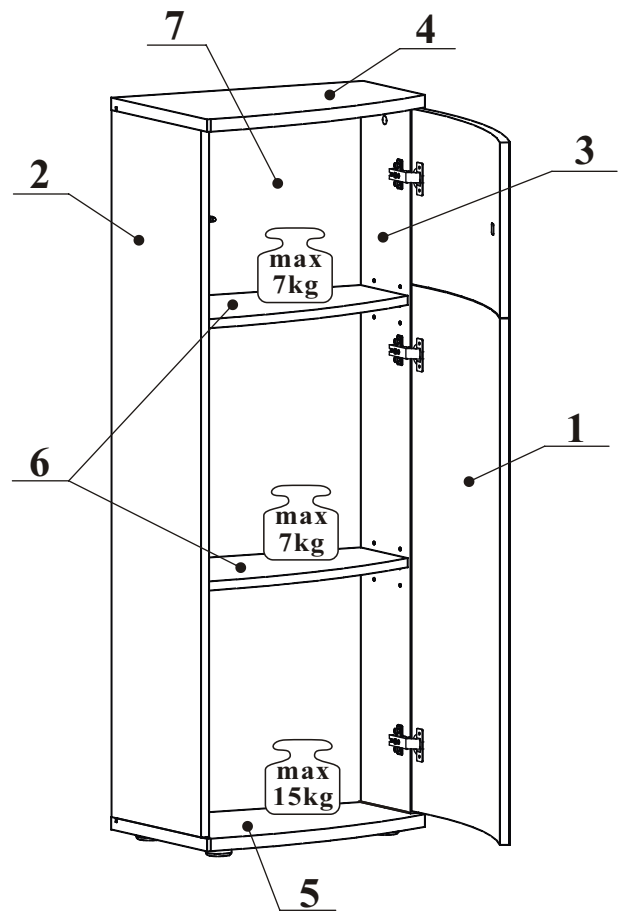

NO	Dim.	Col.-No	Qty
1	504 1237	1	1
2	1245 330	1	1
3	1245 203	1	1
4	501 353	1	1
5	501 353	1	1
6	468 295	1	2
7	1257 480	1	1

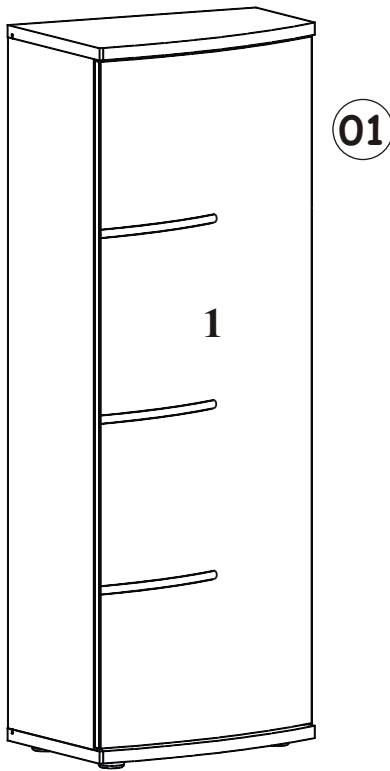
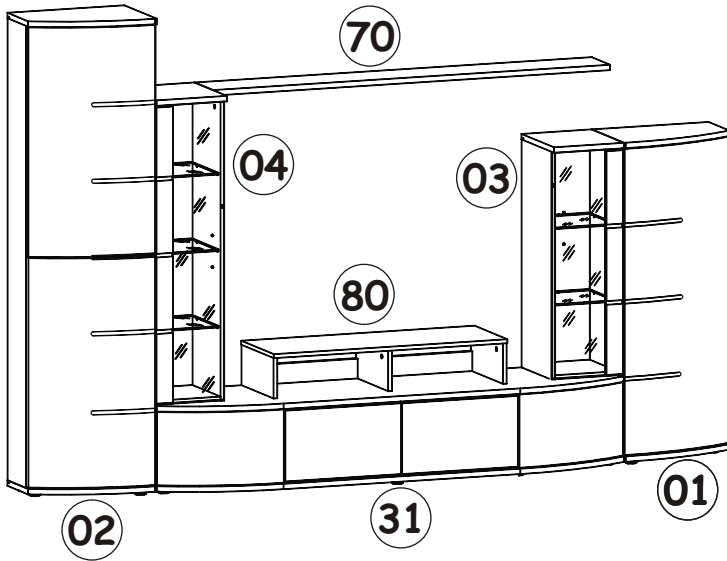
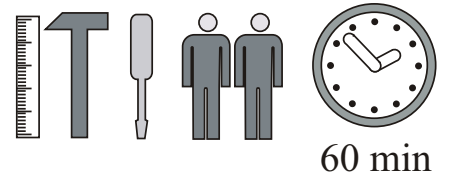

LEAVE TYP 01

A1 X8 ø8x36	B4 X3	B5 X3 ø15x12	G5 X3	B11 X3 Ø7x50	G4 X3
E21 X3 Ø35 H=0	E2 X3 H=0	D10 X10 USØ3,5x13	T2 X1 D10	S1 X12	G7 X8
I11 X4	D11 X4 USØ3,5x25	L1 X1	KR1 X1	G2 X1	

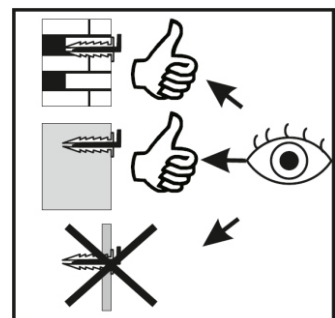
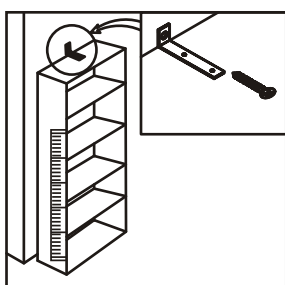
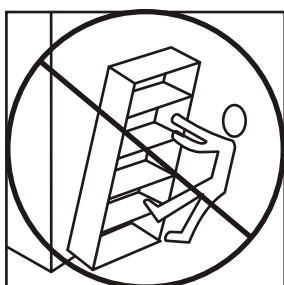
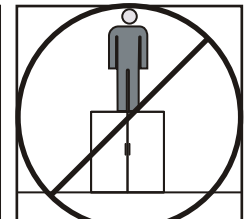
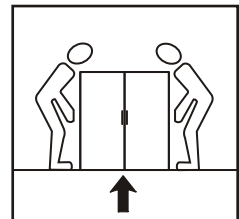
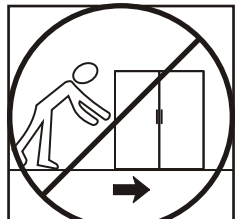
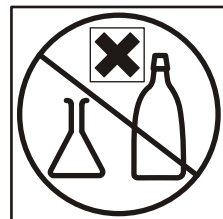
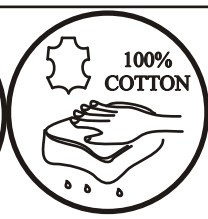
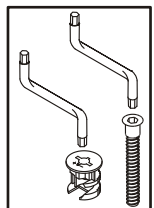
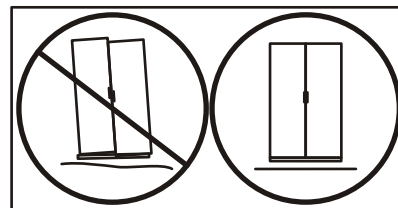
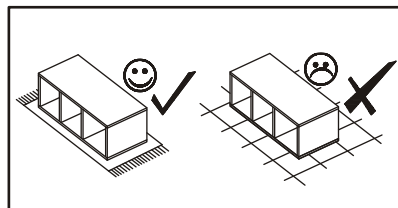
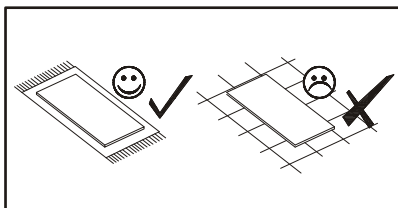
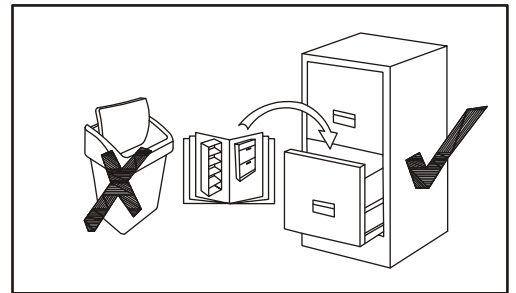
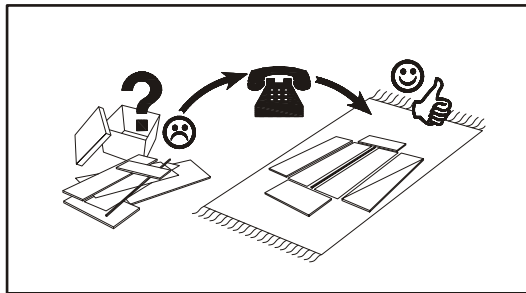
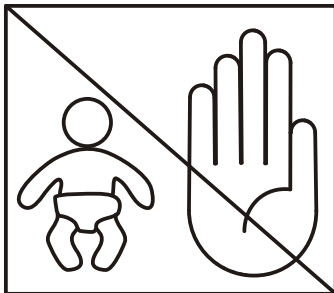
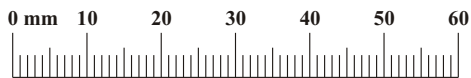

3

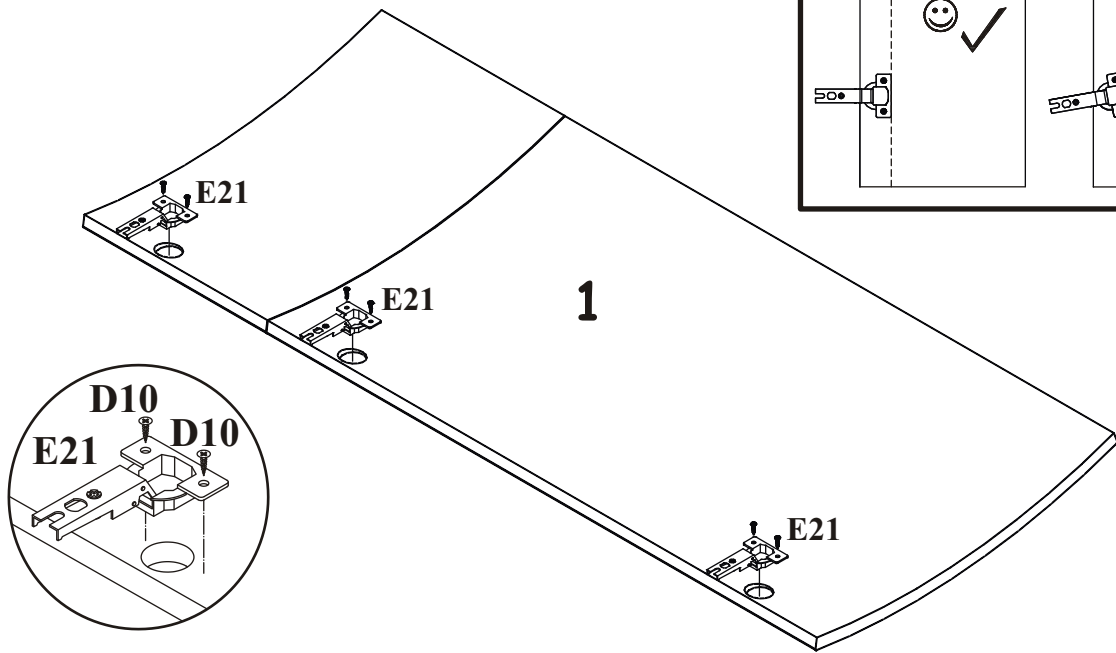

4

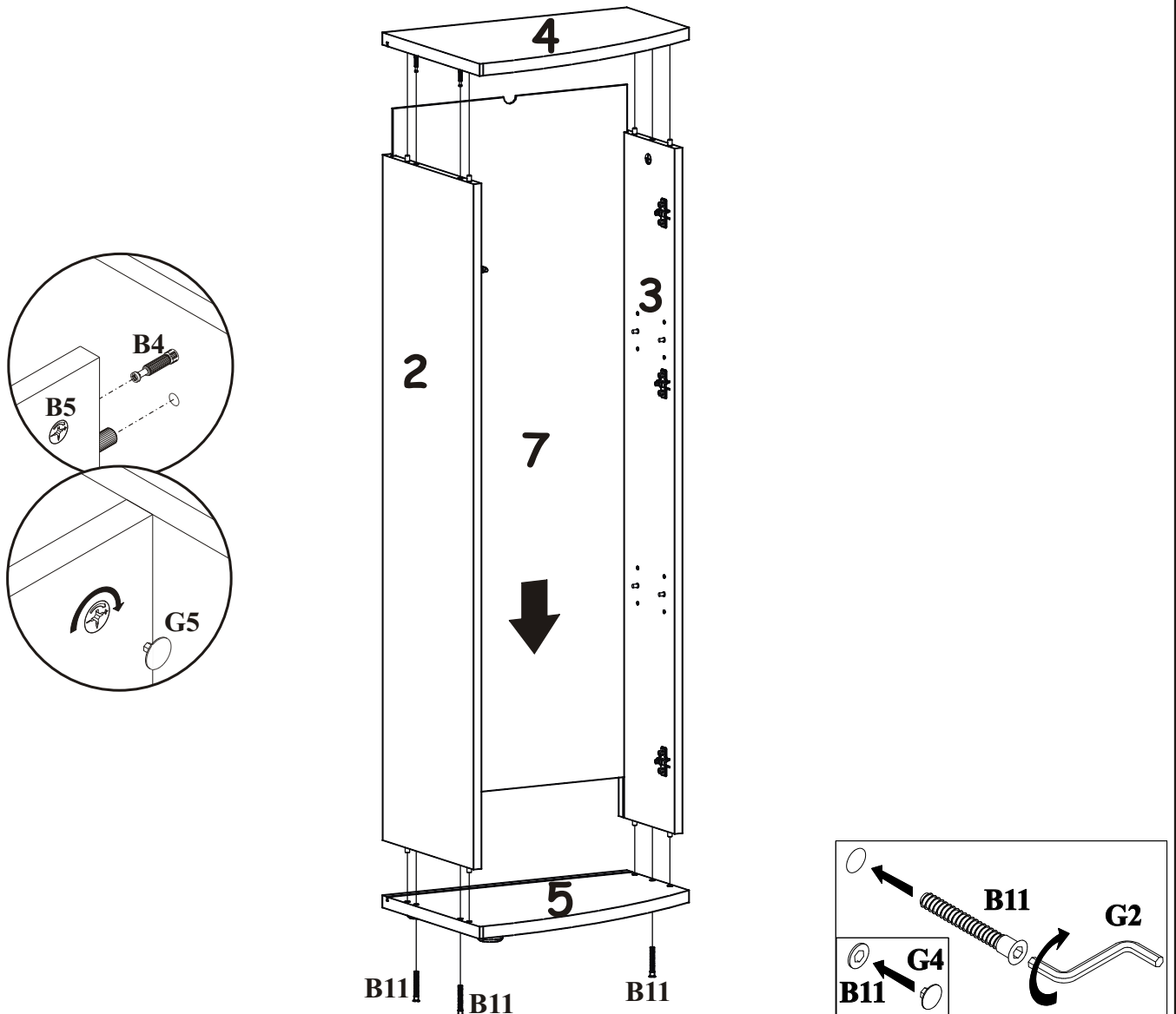

5

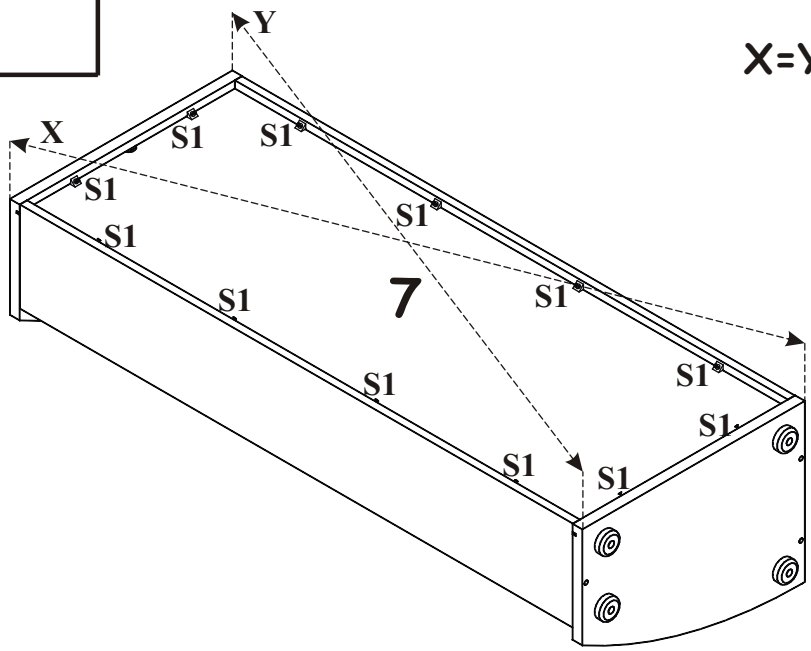
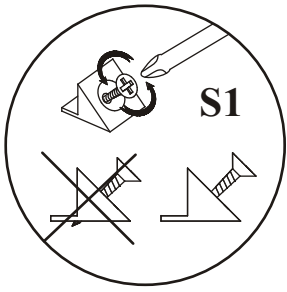

6

