

LEAVE TYP 80

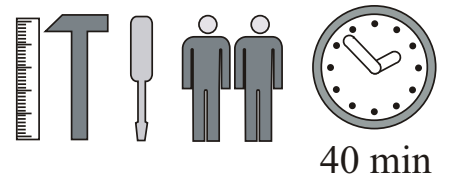
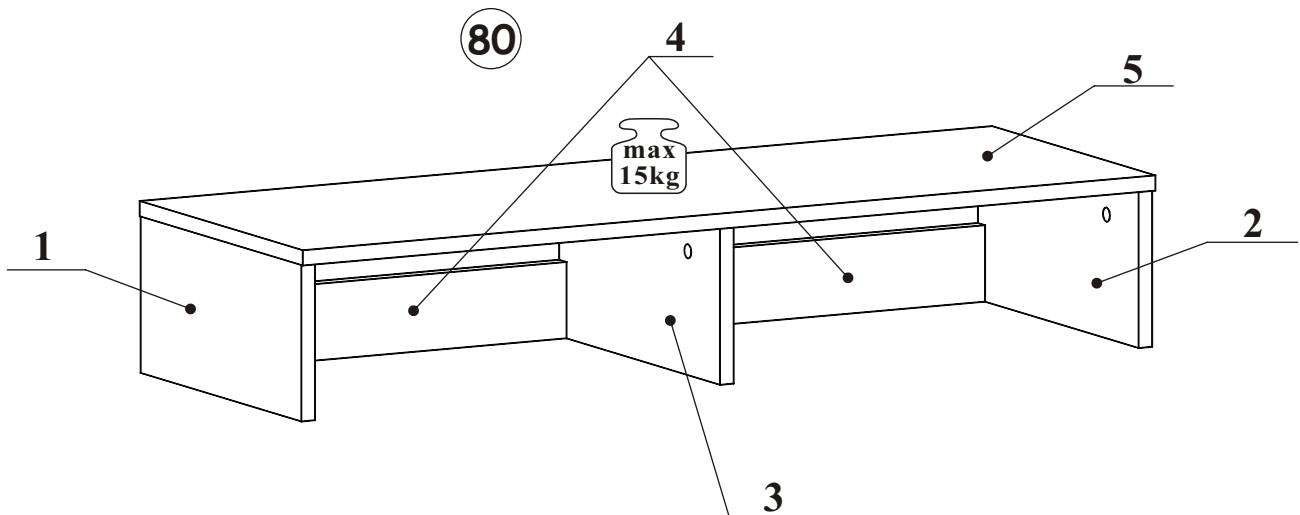
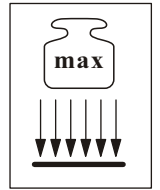
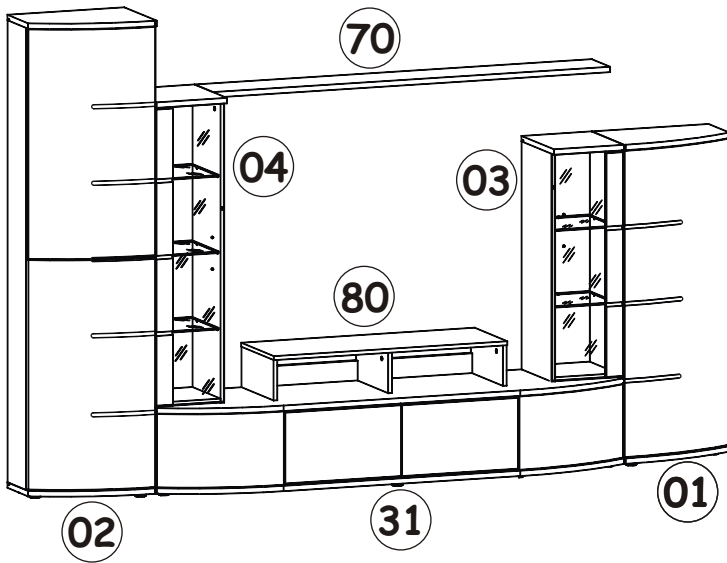

40 min

NO	Dim.		Col.-No	Qty
1	164	350	1	1
2	164	350	1	1
3	164	350	1	1
4	475	80	1	2
5	1001	355	1	1

LEAVE TYP 80

A1 X10 ø8x36	B4 X8	B5 X10 ø15x12	G5 X10	B6 X1 Ø7x78	G2 X1
--------------------	----------	---------------------	-----------	-------------------	----------

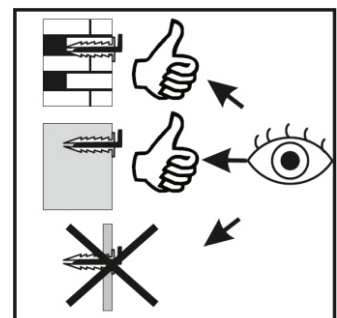
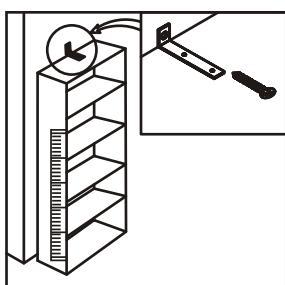
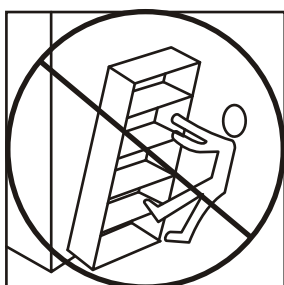
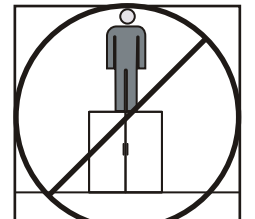
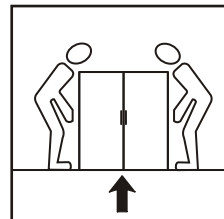
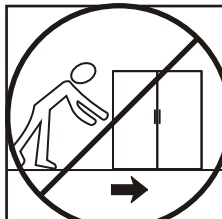
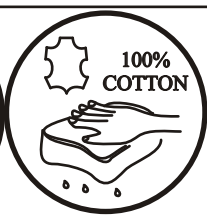
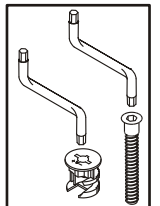
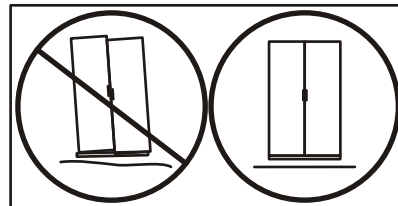
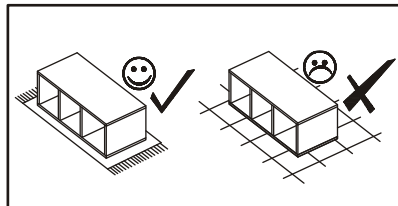
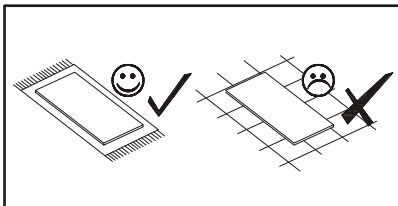
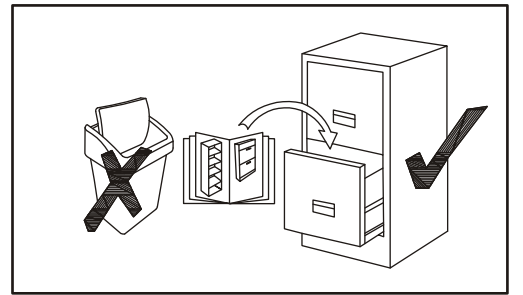
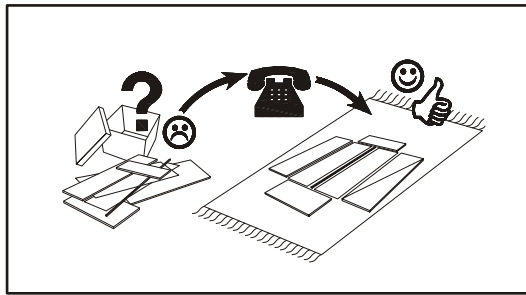
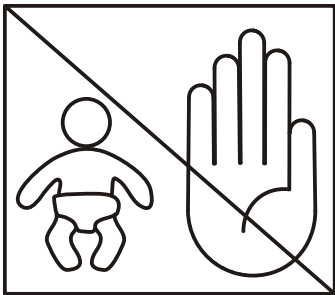
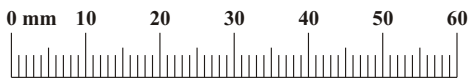

LEAVE TYP 80

1

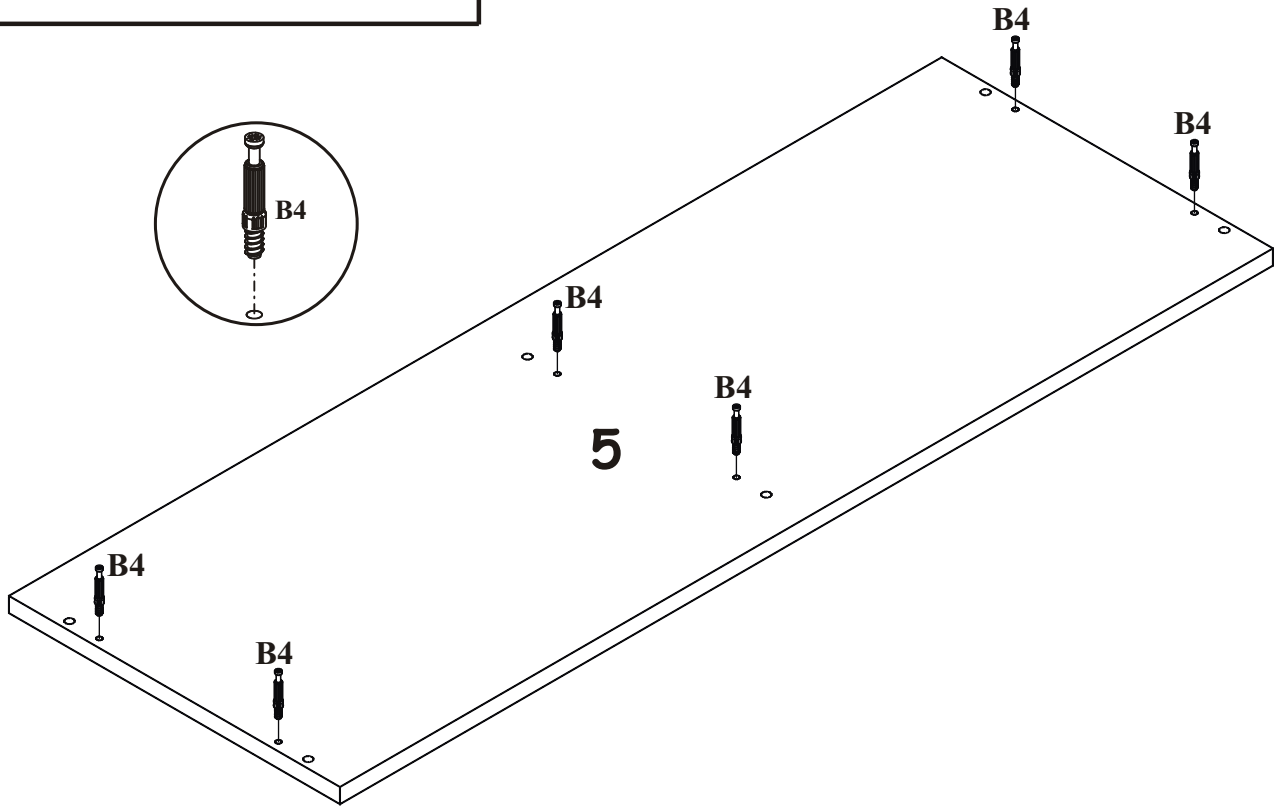

2

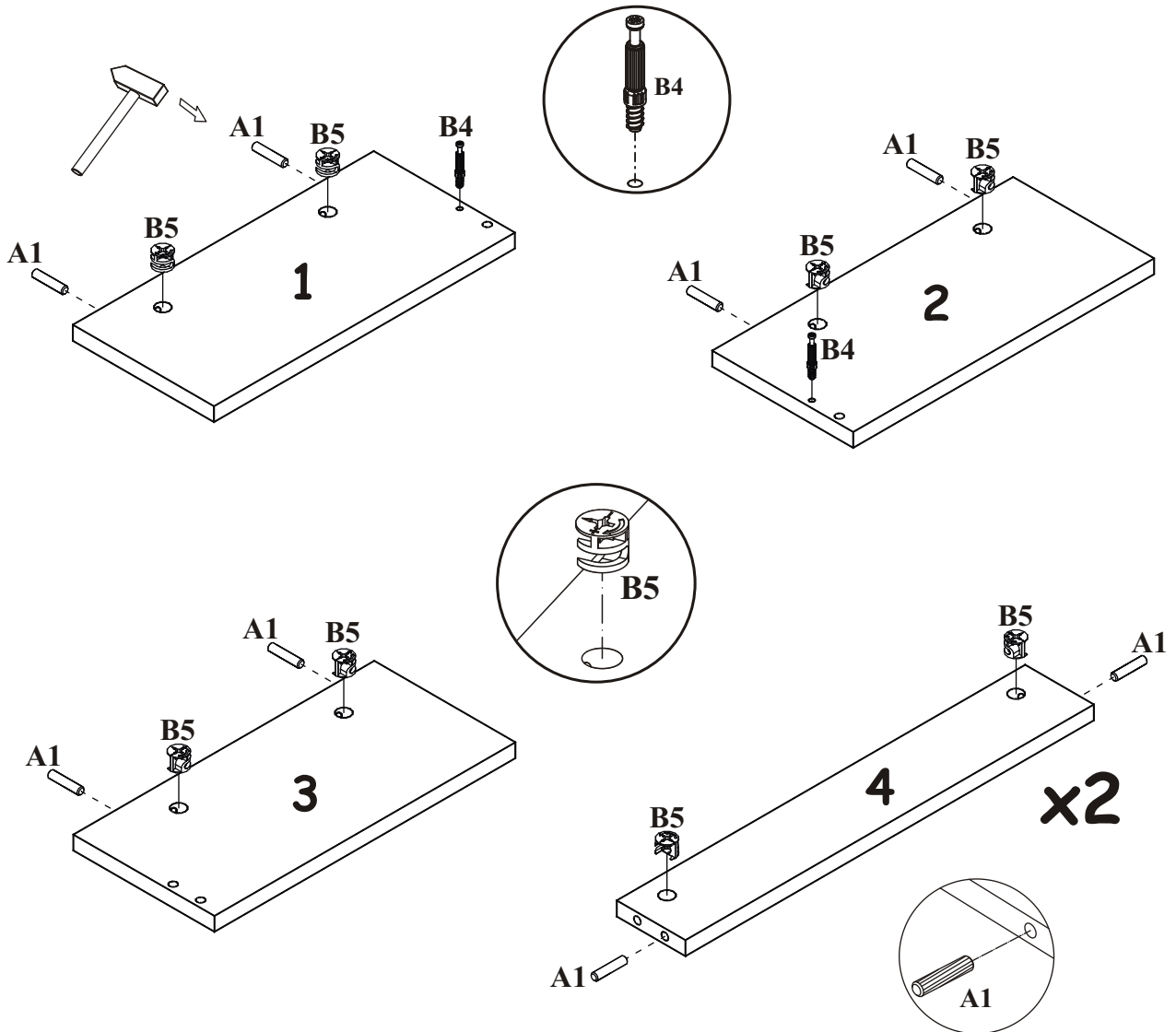

3

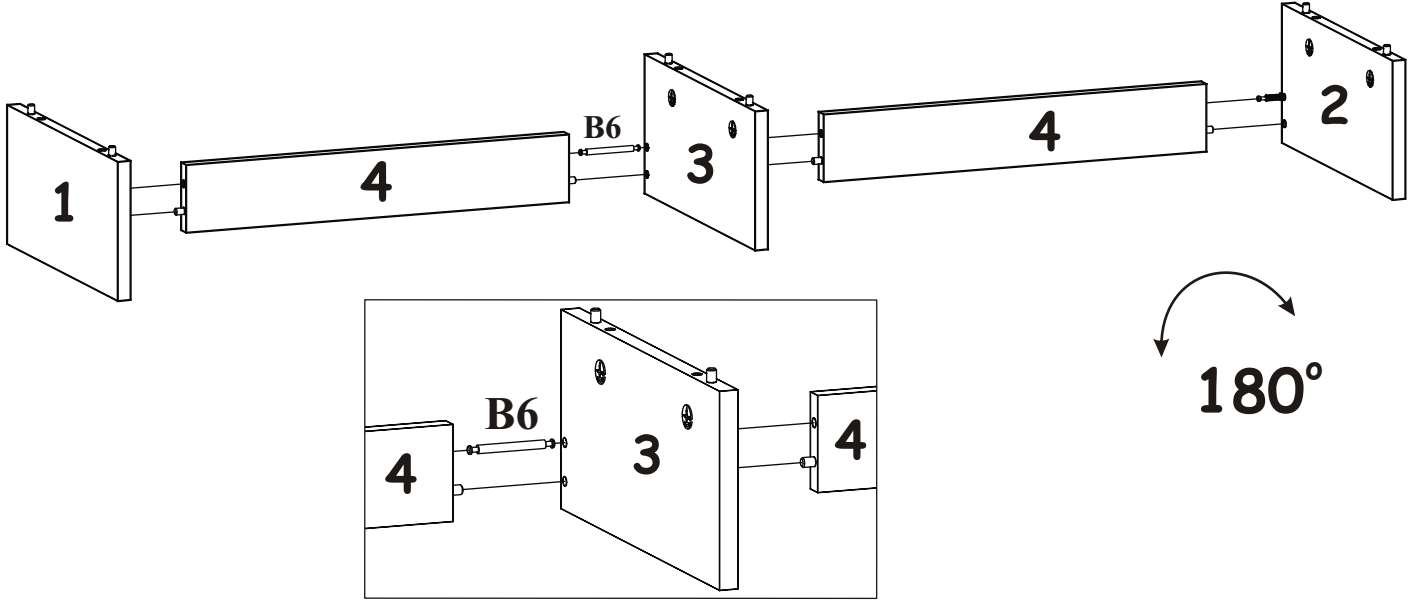
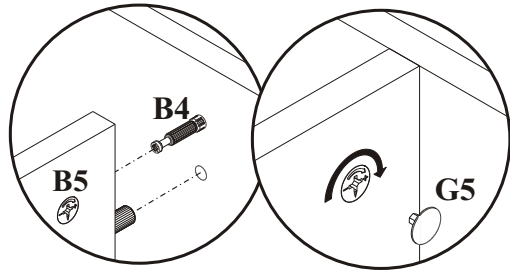

4

