

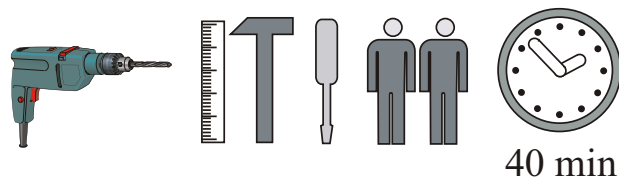

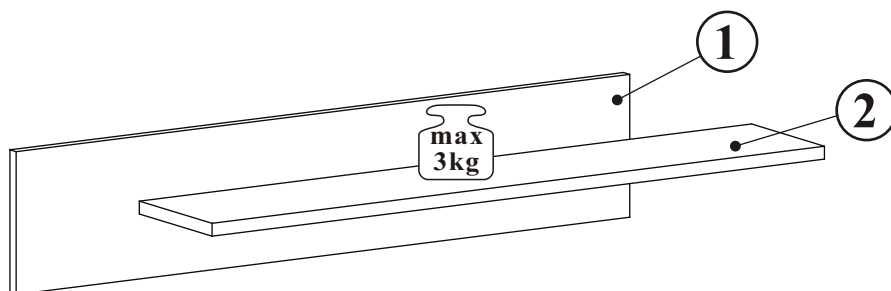

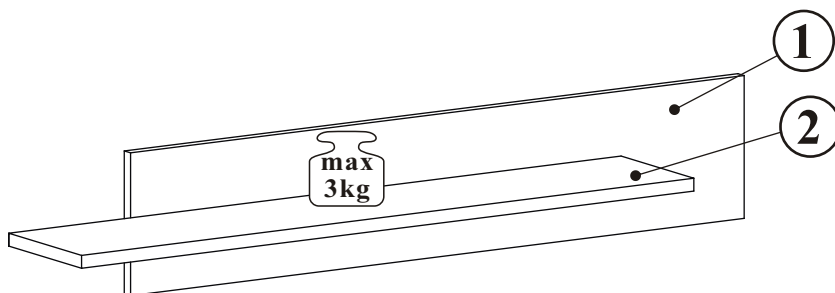

GALINO 23_MX

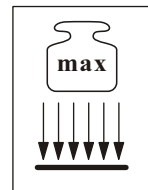
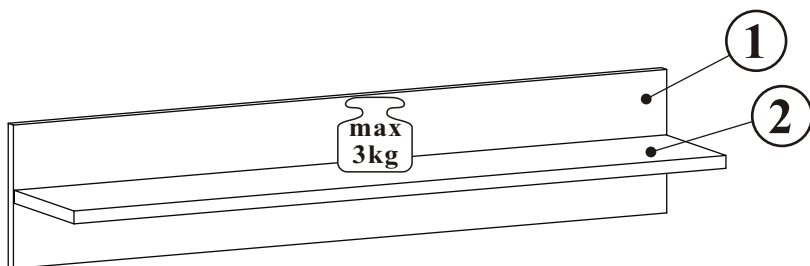
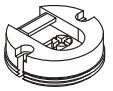

NO	Dim.		Col.-No	Qty
1	1002	200	1	2
2	1000	185	1	2

GALINO 23_MX

ZM1		D20		B11		G4		KR2		G2	
x4		x8	ESØ6x9,5	x12	Ø7x50	x12		x4		x1	

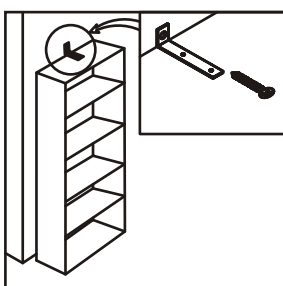
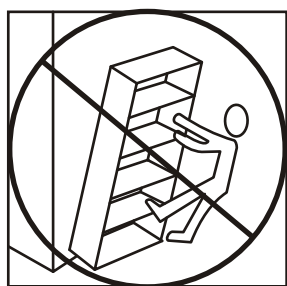
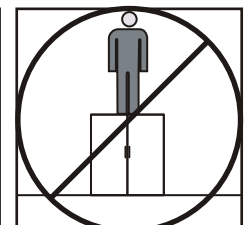
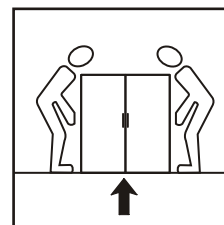
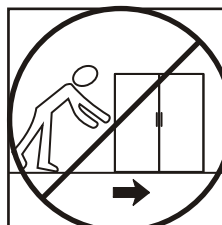
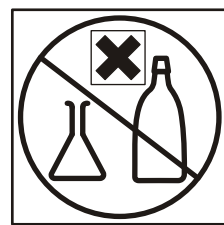
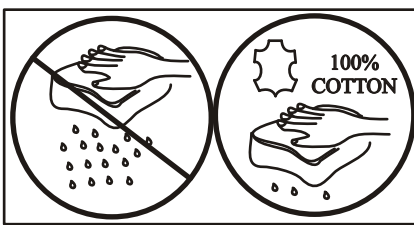
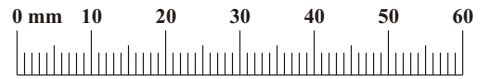

1-3

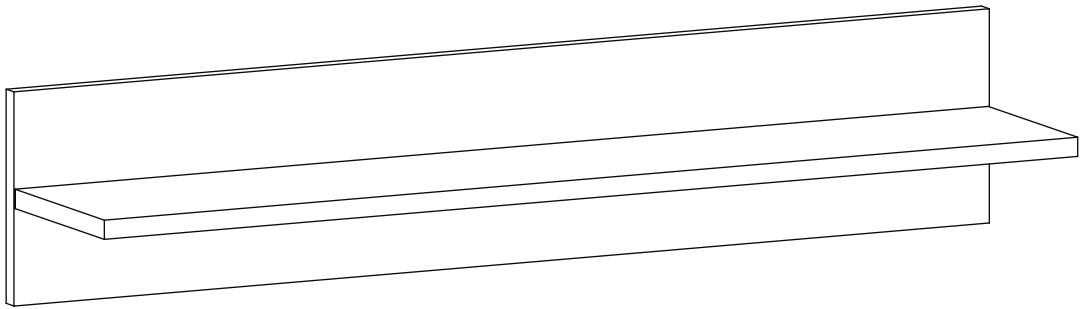

4-6

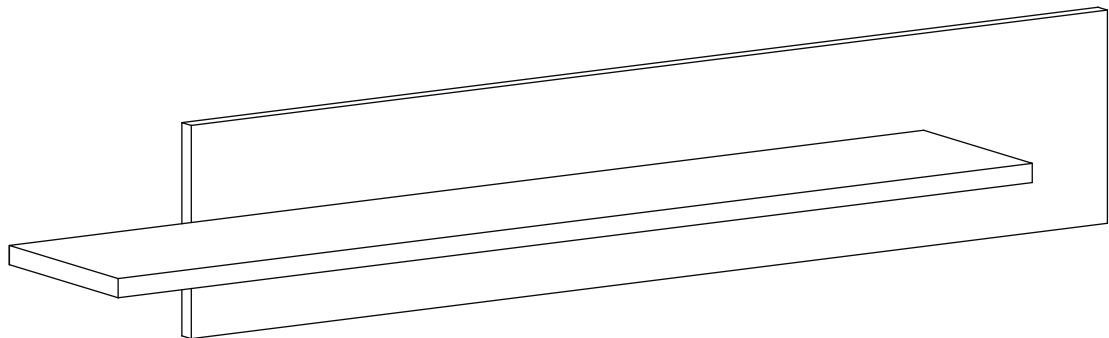

7-9

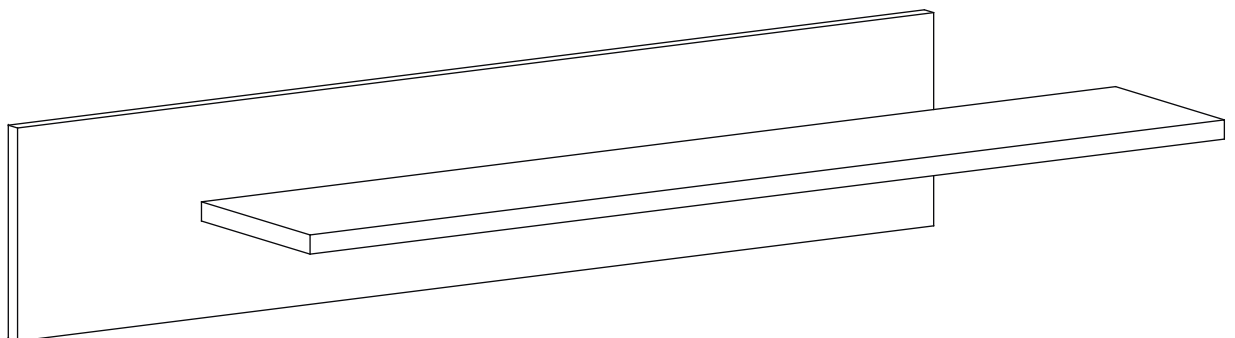

GALINO 23_MX

1

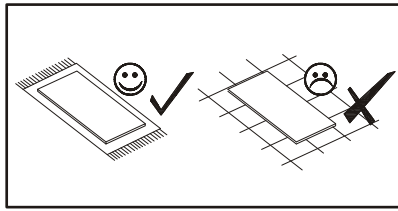

ZM1
x4

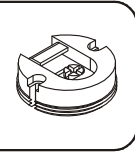

D20
x8

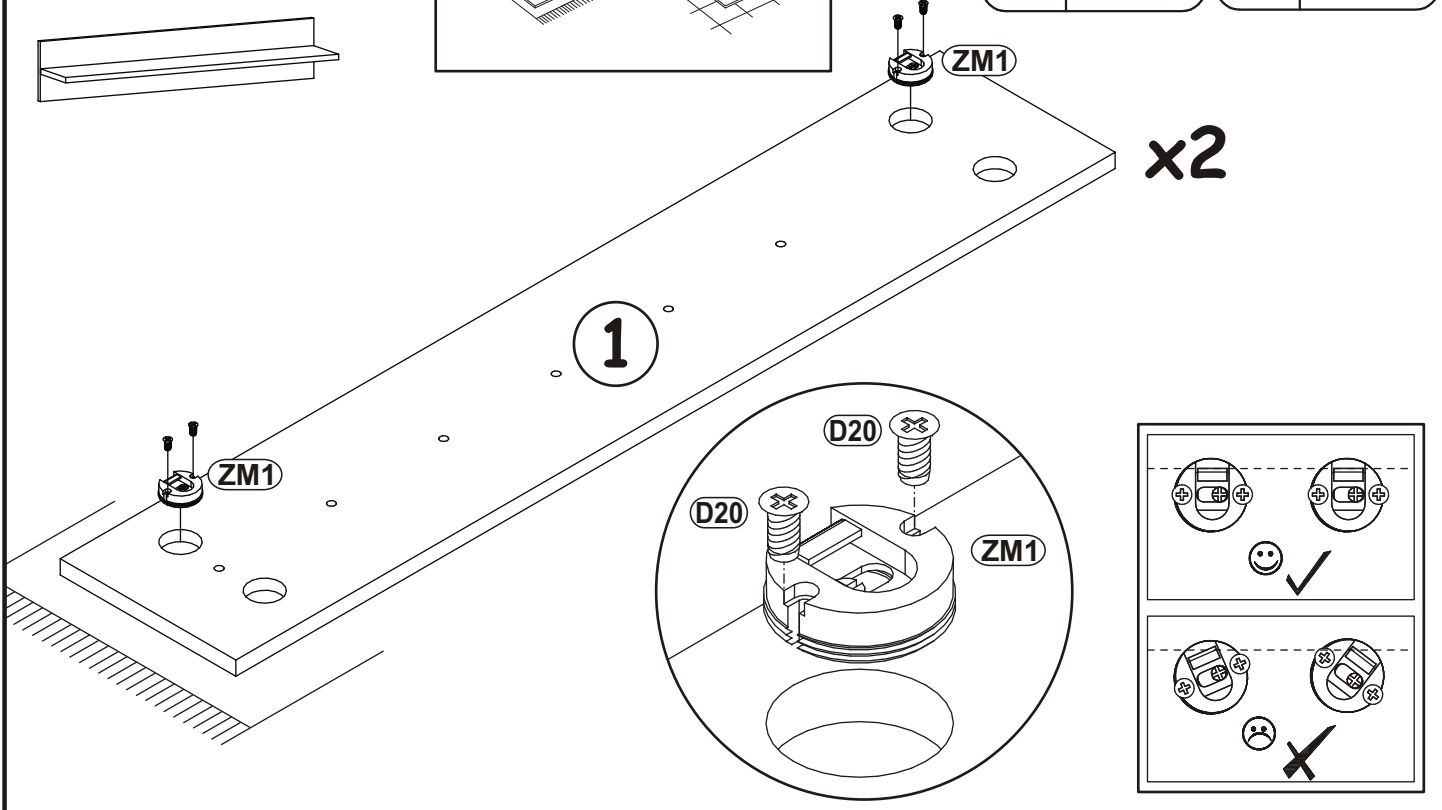
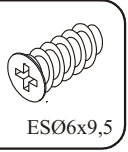

2

B11
x12

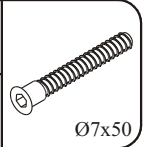

G4
x12

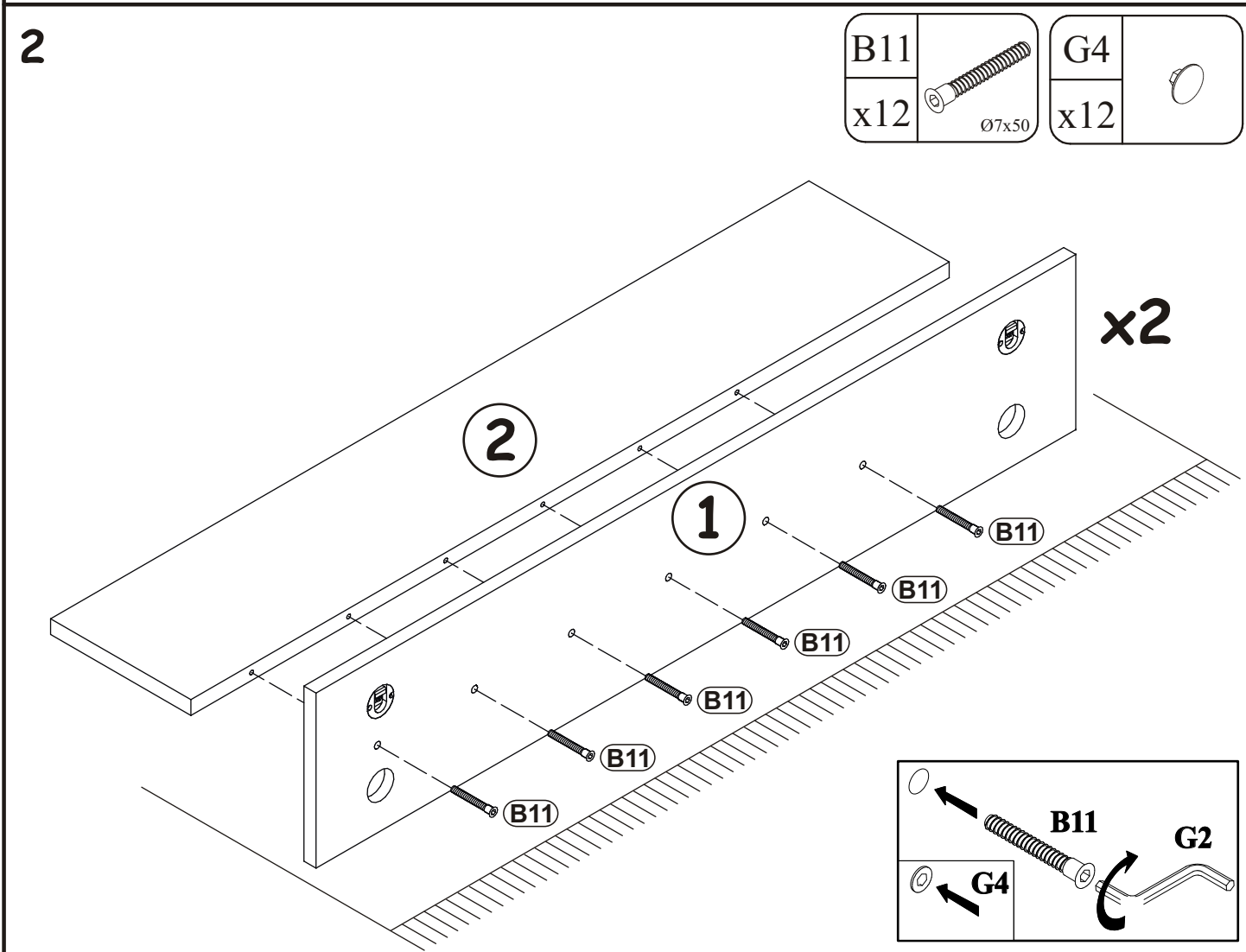
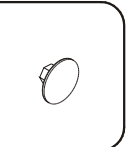

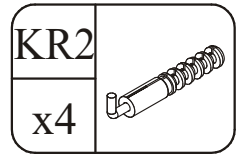

3

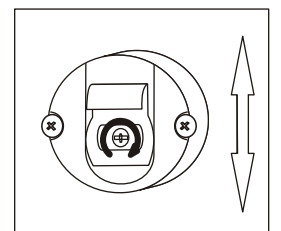
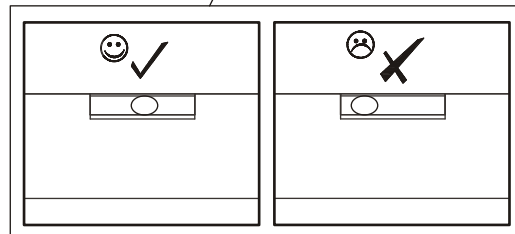
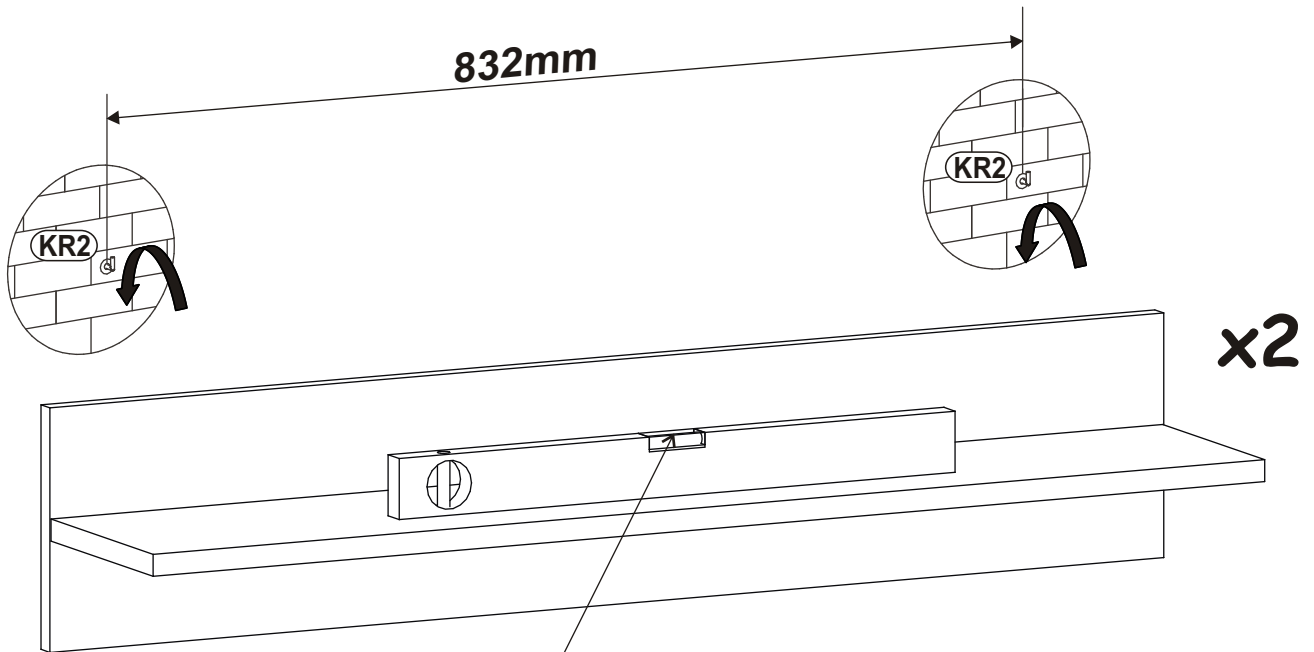
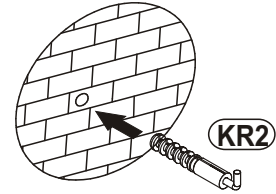
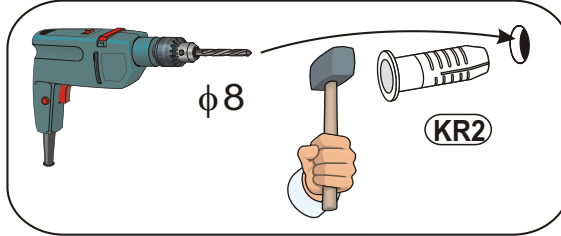
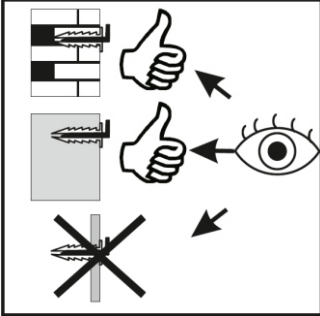

4

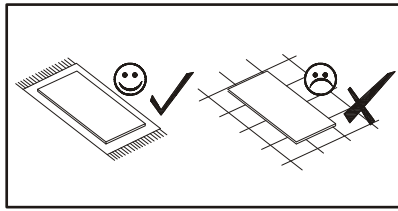

ZM1		D20	
x4		x8	ESØ6x9,5

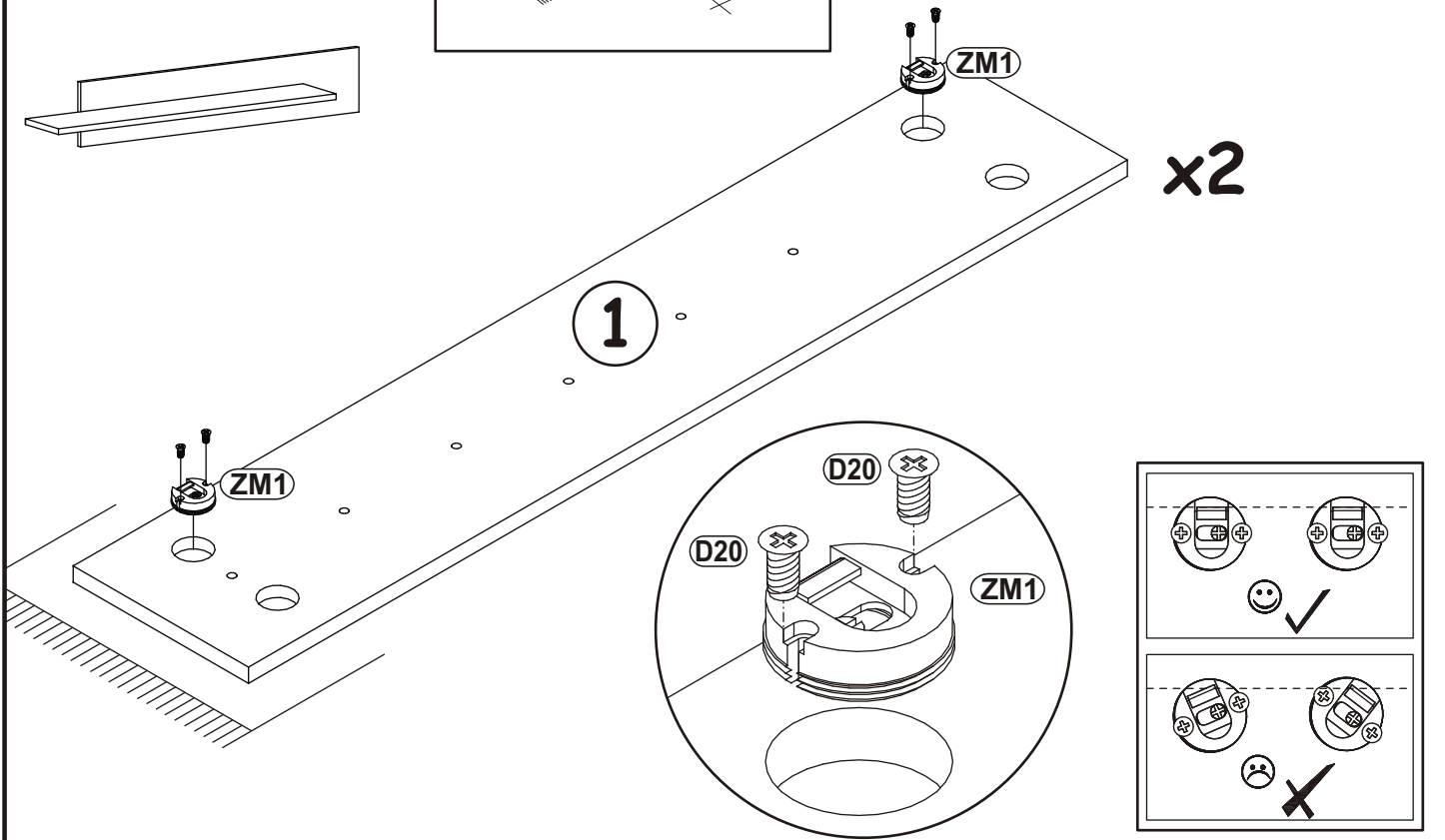

5

B11		G4	
x12	Ø7x50	x12	

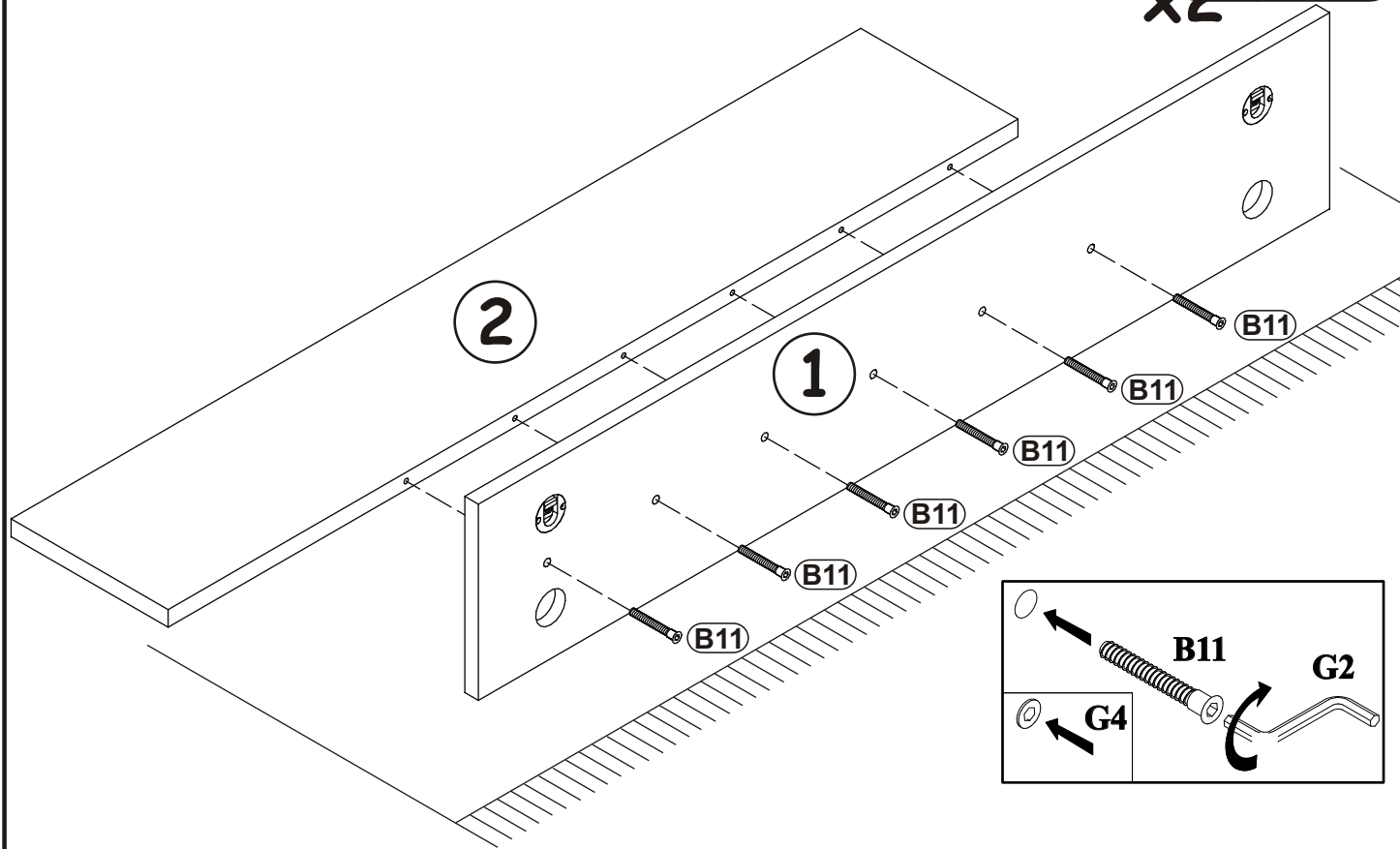

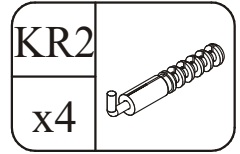

6

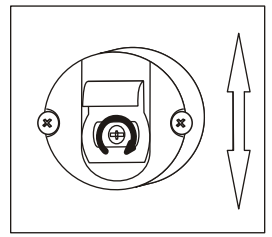
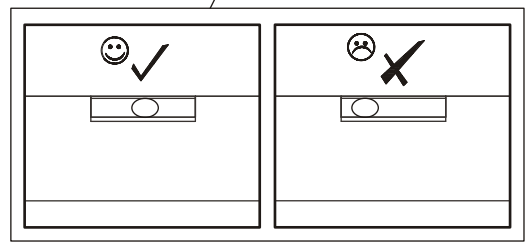
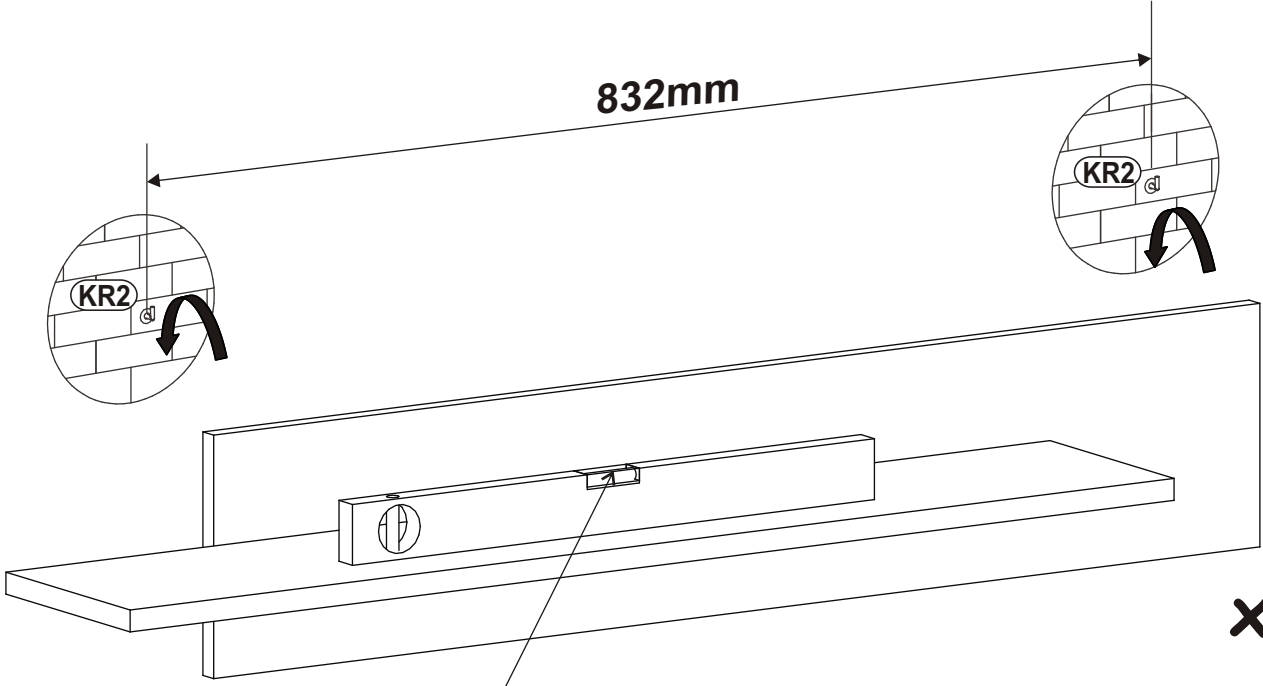
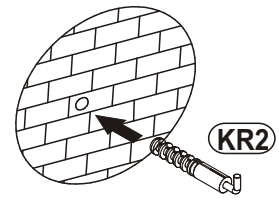
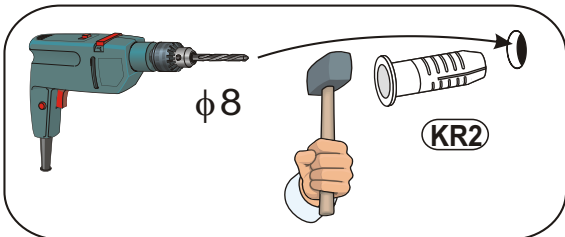
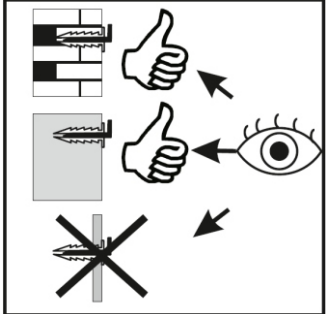

7

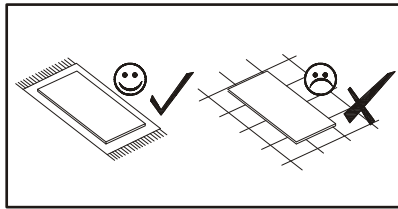

ZM1		D20	
x4		x8	ESØ6x9,5

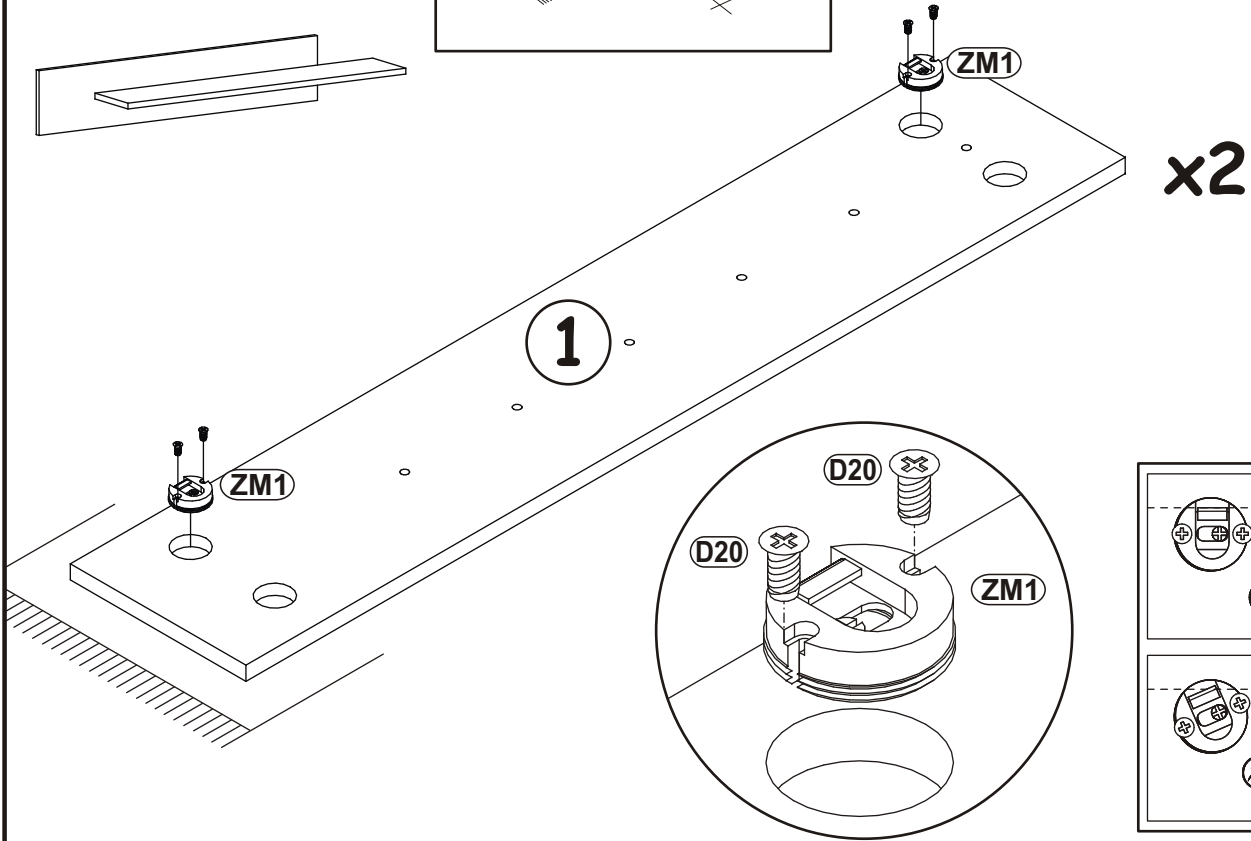

8

B11		G4	
x12	Ø7x50	x12	

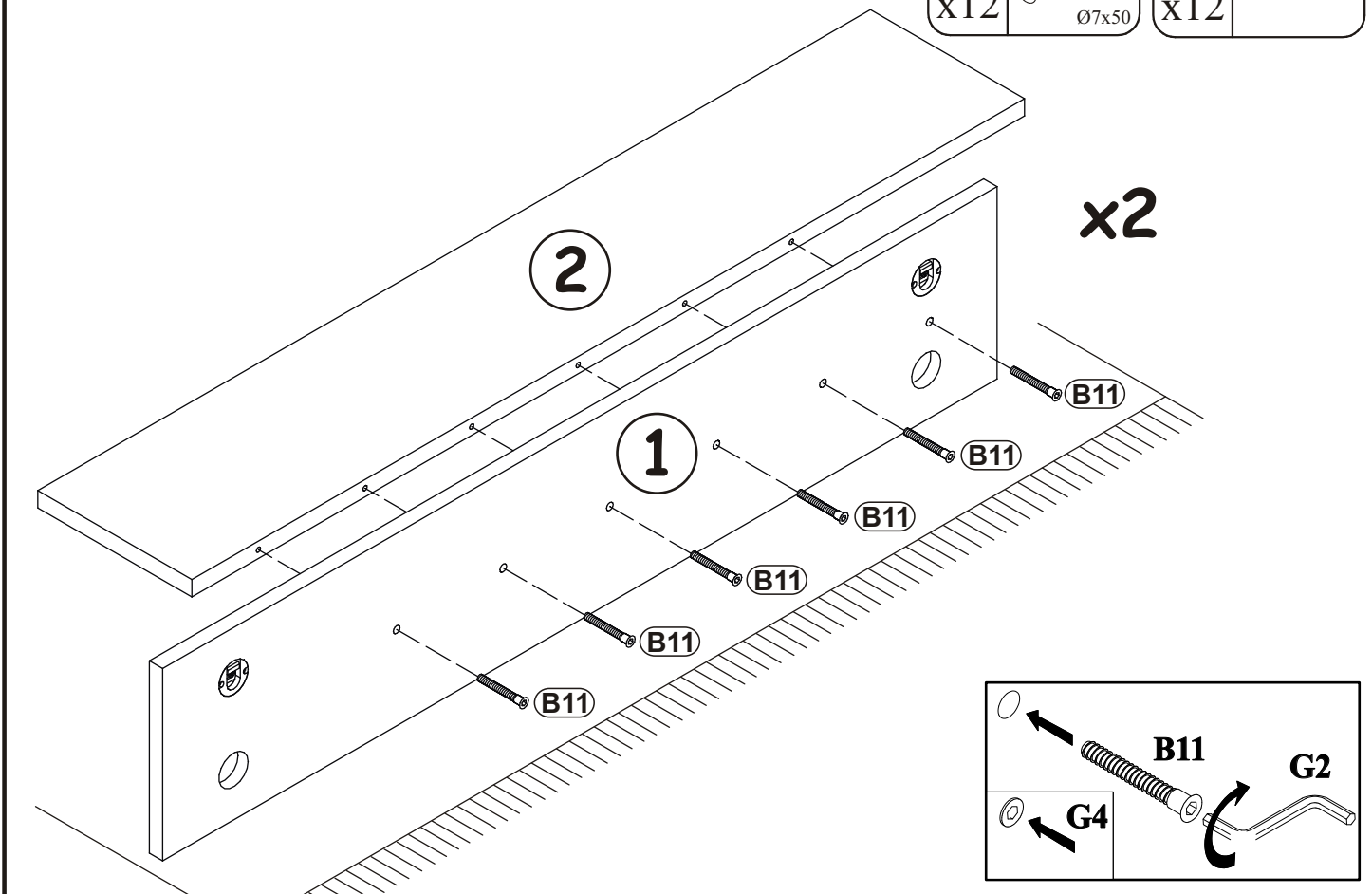

9

