

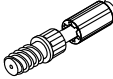









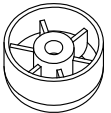

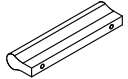
A1 X16  ø8x36	B4 X8 	B5 X8  ø15x12	G5 X8 	ST2 X4 	D11 X4  USØ3,5x25
KL X2 	UP6 X4  UPØ4x30	B11 X12  Ø7x50	G4 X12 	D10 X8  USØ3,5x13	G2 X1 
S1 X4 	UP13 X6  UPØ3x16	H5 X2 	D27 X8  ESØ6x8		

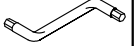
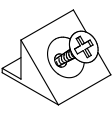

2

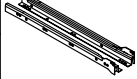

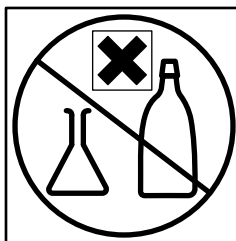
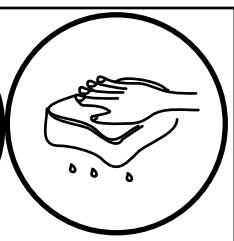
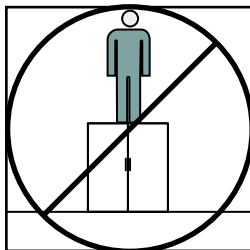
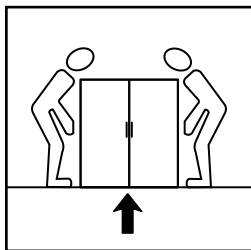
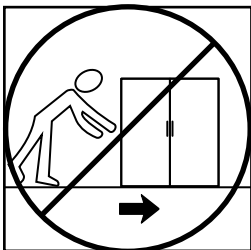
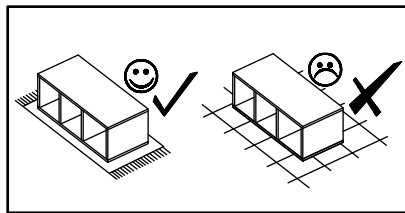
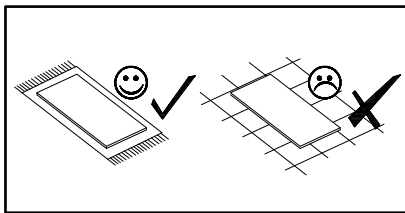
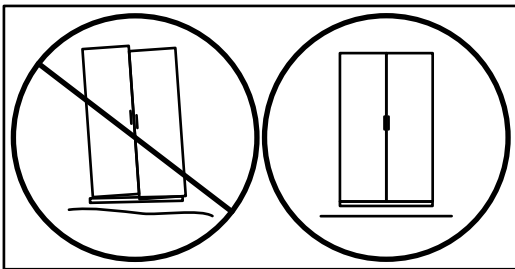
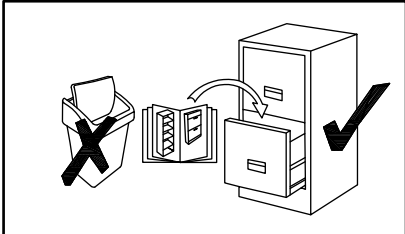
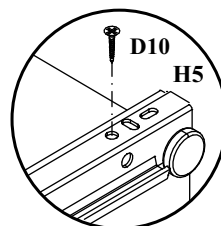
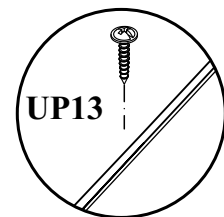
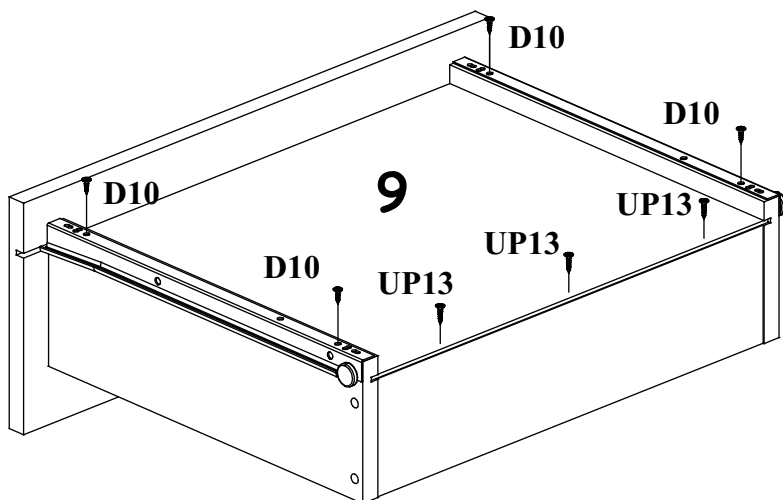
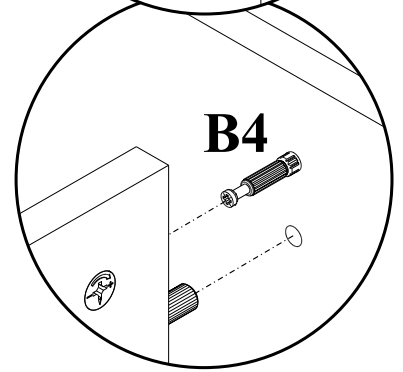
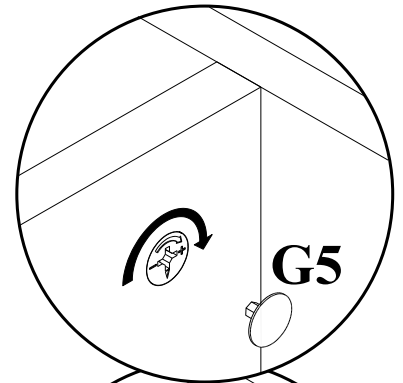
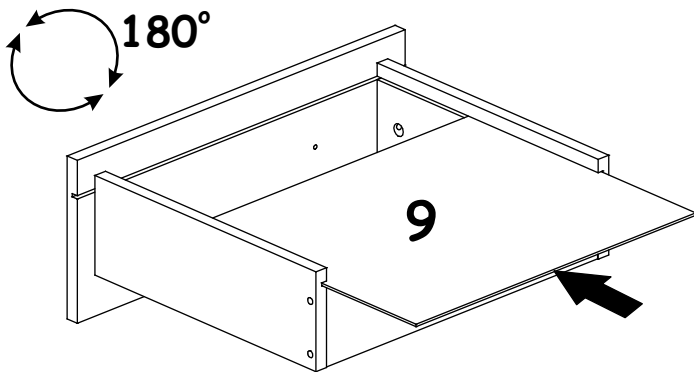
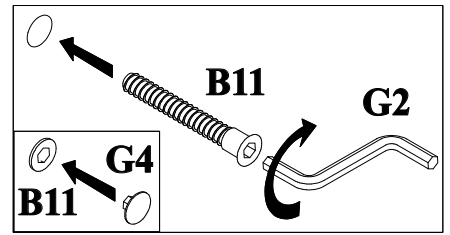
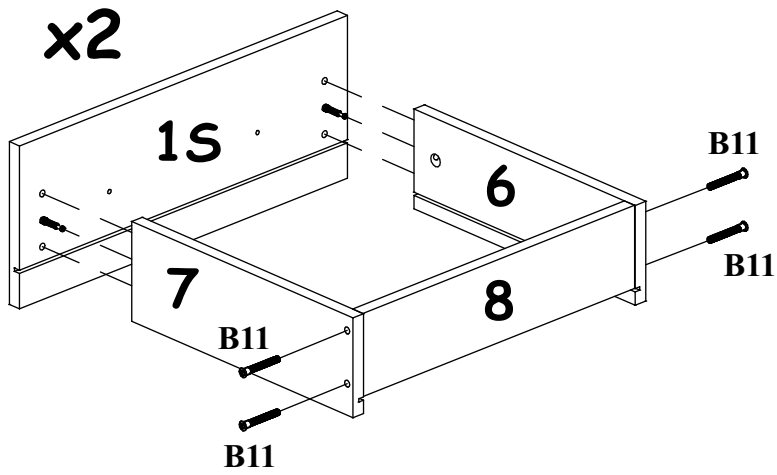
3

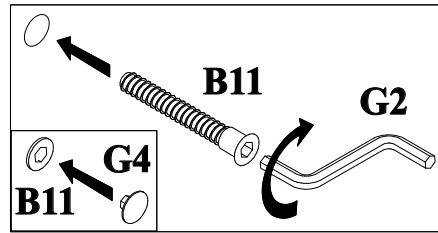
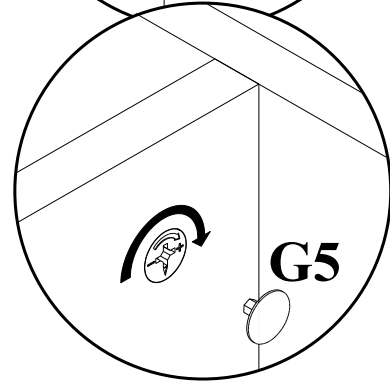
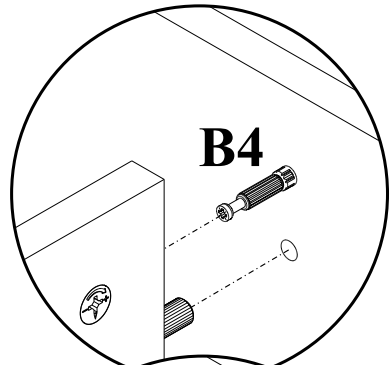
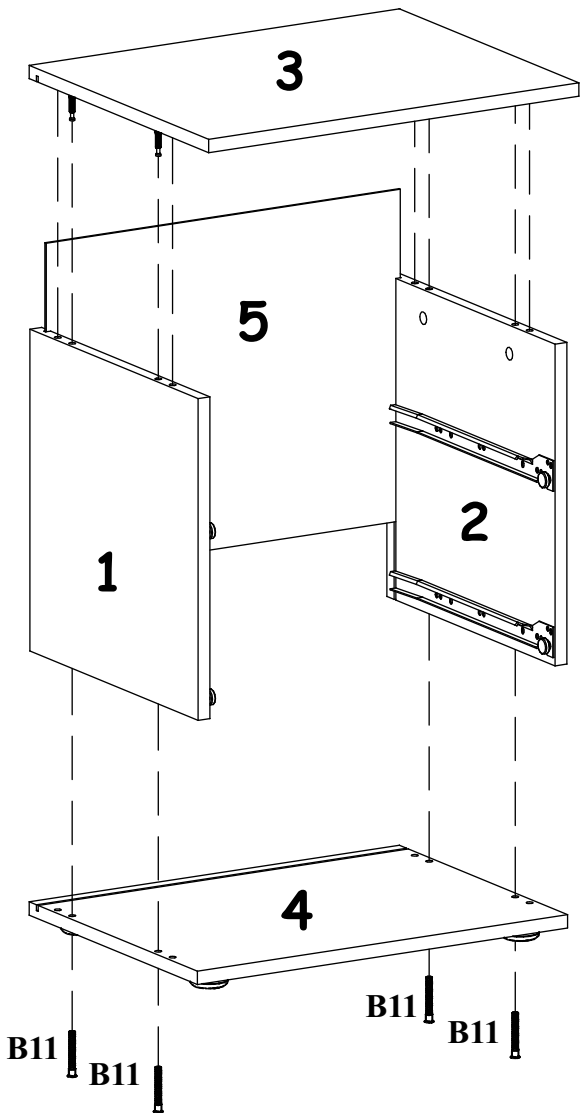

4

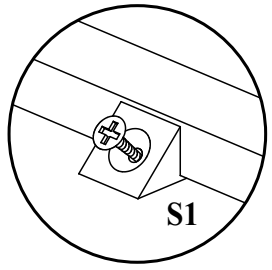
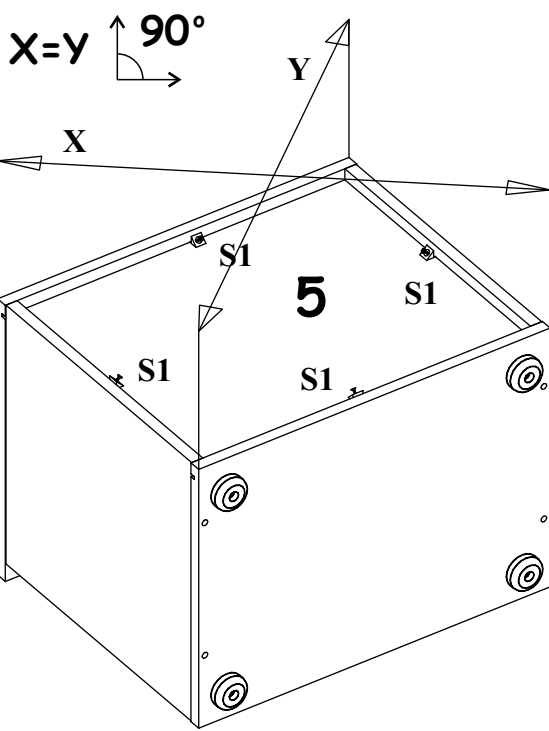

5

