

LIAM-__LM WSN

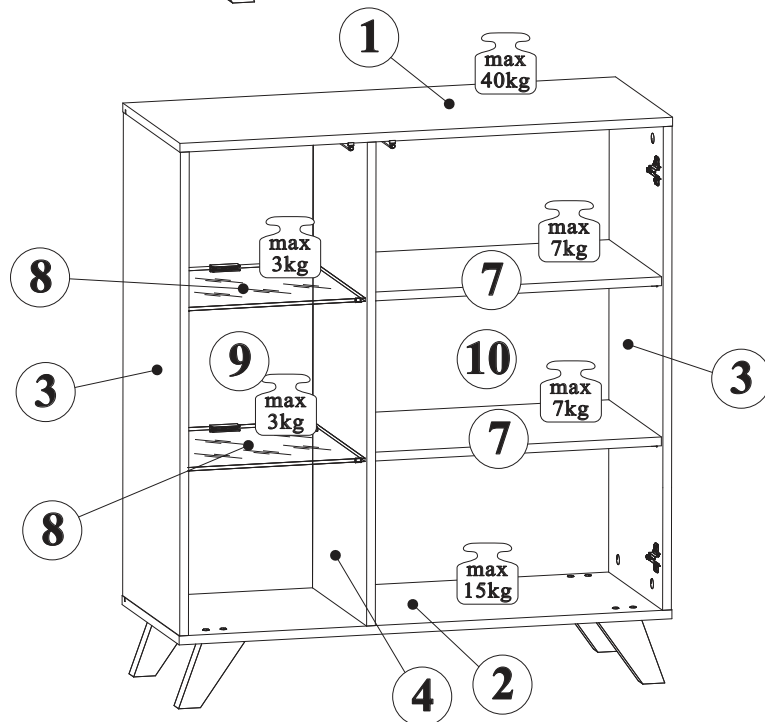

NO	Dim (mm)			Col.-No	Qty
1	902	376	16	1/2	1
2	902	376	16	1/2	1
3	870	376	16	1/2	2
4	870	356	16	2/2	1
5	896	546	16	2/2	1
6	896	346	21	2/2	1
7	526	346	16	1/2	2
8	325	346	6	1/2	2
9	882	340	3	2/2	1
10	882	540	3	2/2	1

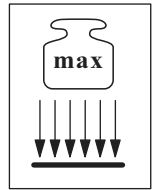
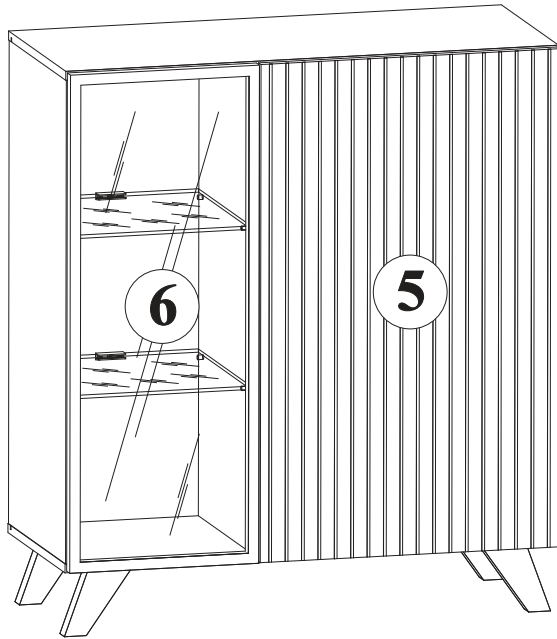
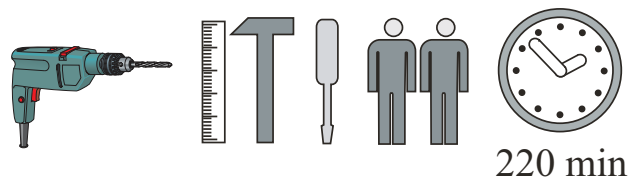

220 min

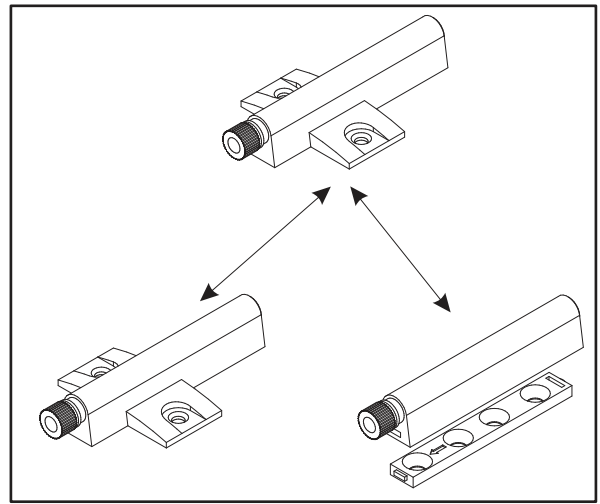
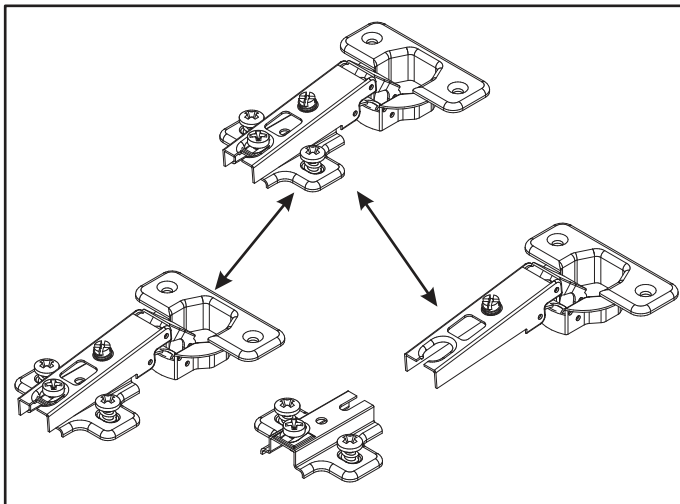
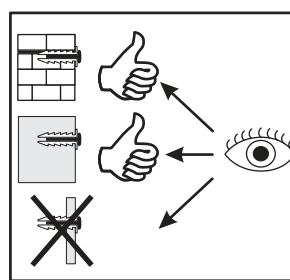
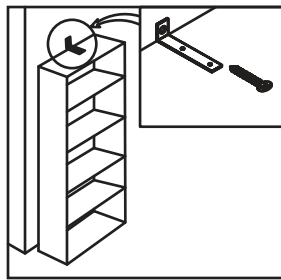
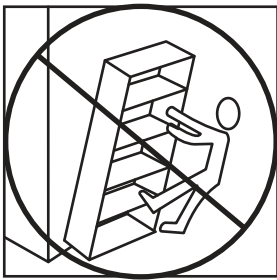
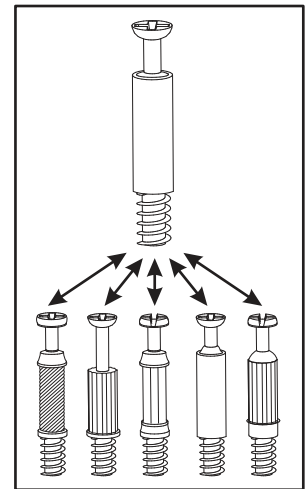
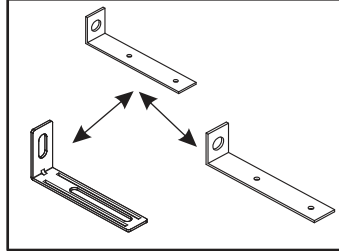
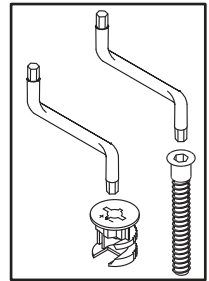
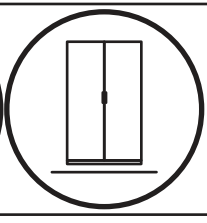
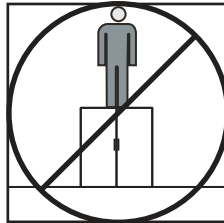
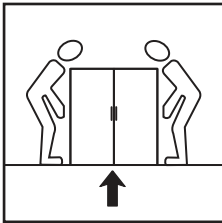
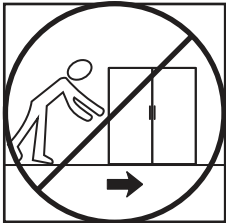
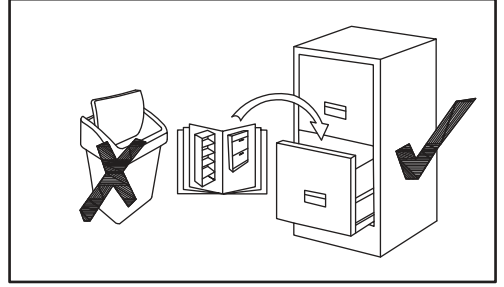
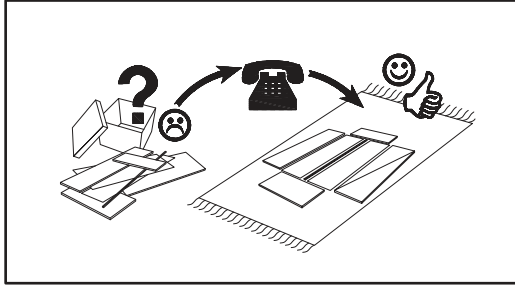
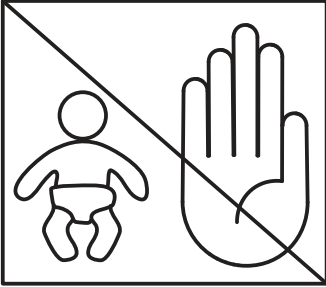
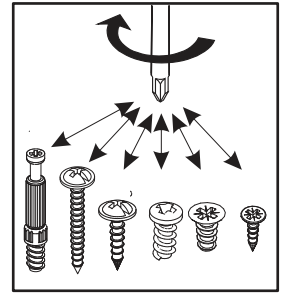
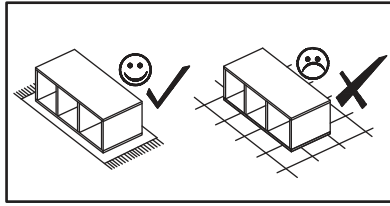
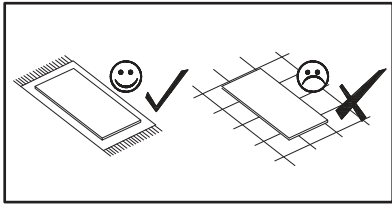

A1 x12 Ø8x36	B11 x8 Ø7x50	G4 x8	B4 x12	B5 x12 Ø15x12	G5 x12
E21 x2 Ø35 H=0	E2 x4 H=0	E38 x2 H=0	T3/T5 x2	S1 x16	G16 x6
G7 x8	G20 x8	SK x4 H=120	LED x1 1x2	UP13 x6 UPØ3x16	D10 x10 USØ3,5x13
KR1 x1 Ø8	L1 x1	G2 x1			

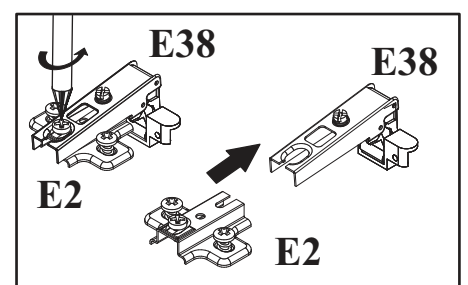
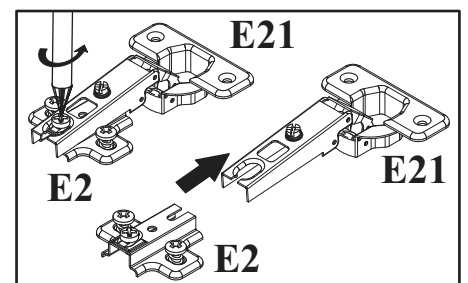

1

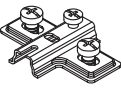
E2	
x2	H=0

A1	
x4	ø8x36

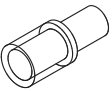
G20	
x4	

B5	
x4	Ø15x12

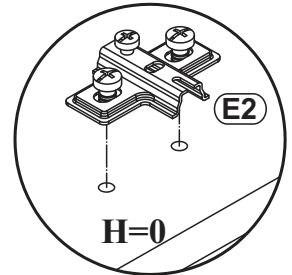
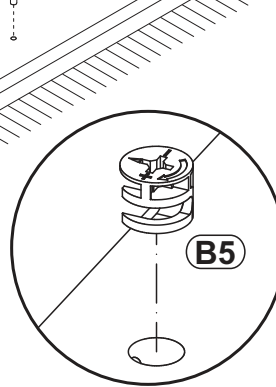
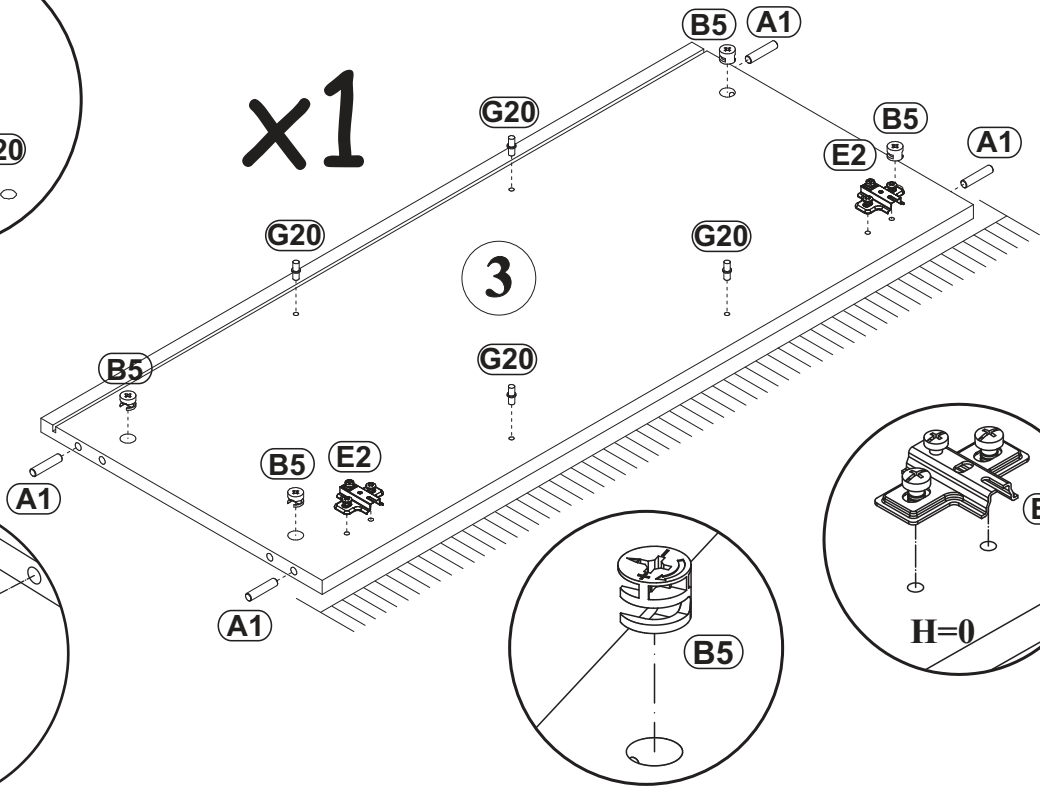
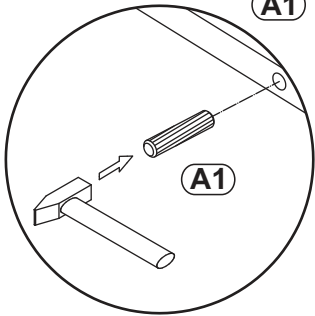
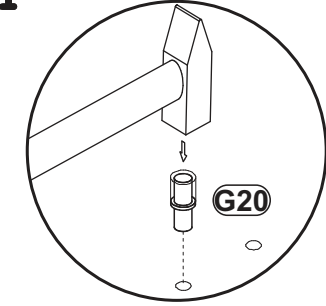

2

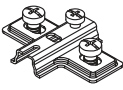
E2	
x2	H=0

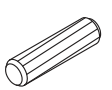
A1	
x4	ø8x36

B5	
x4	Ø15x12

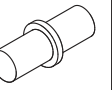
G7	
x4	

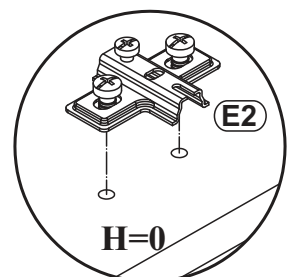
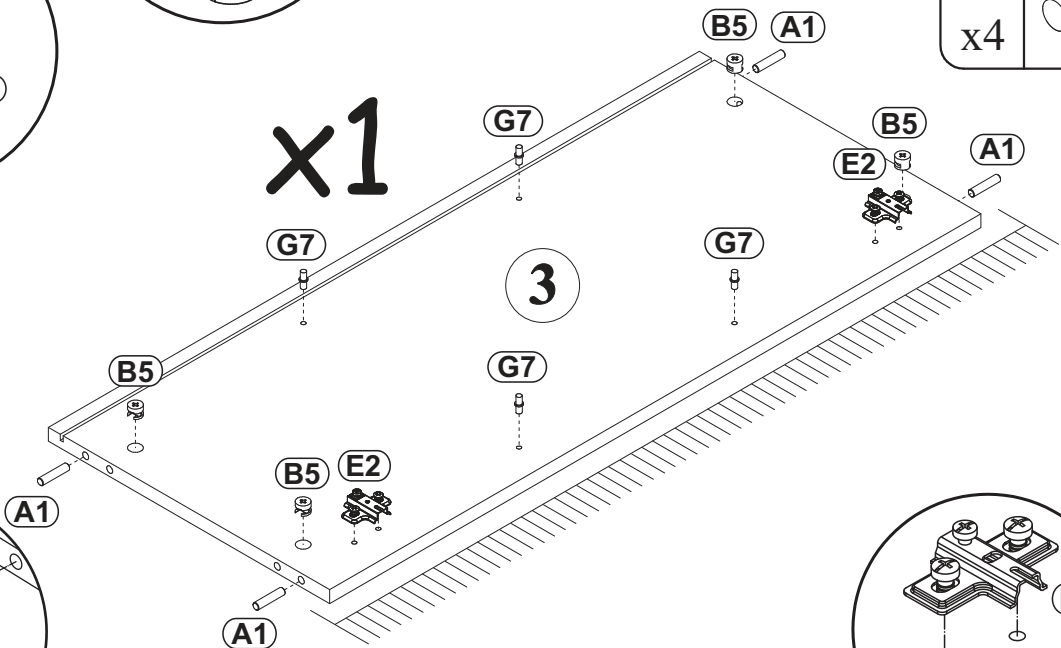
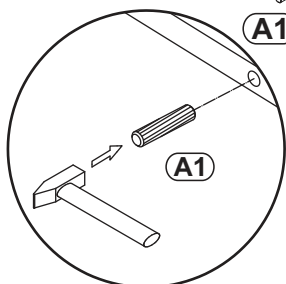
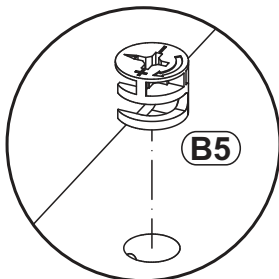
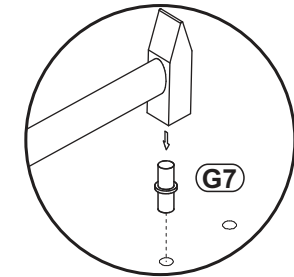

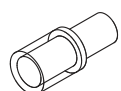
G20	
x4	

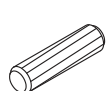
A1	
x4	ø8x36

B5	
x4	Ø15x12

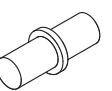
G7	
x4	

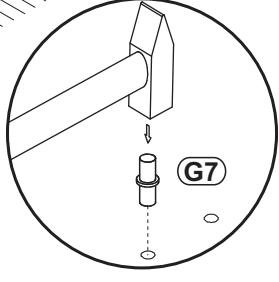
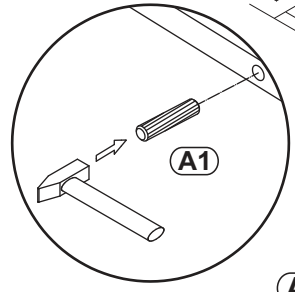
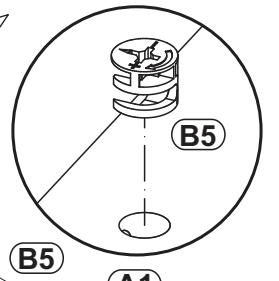
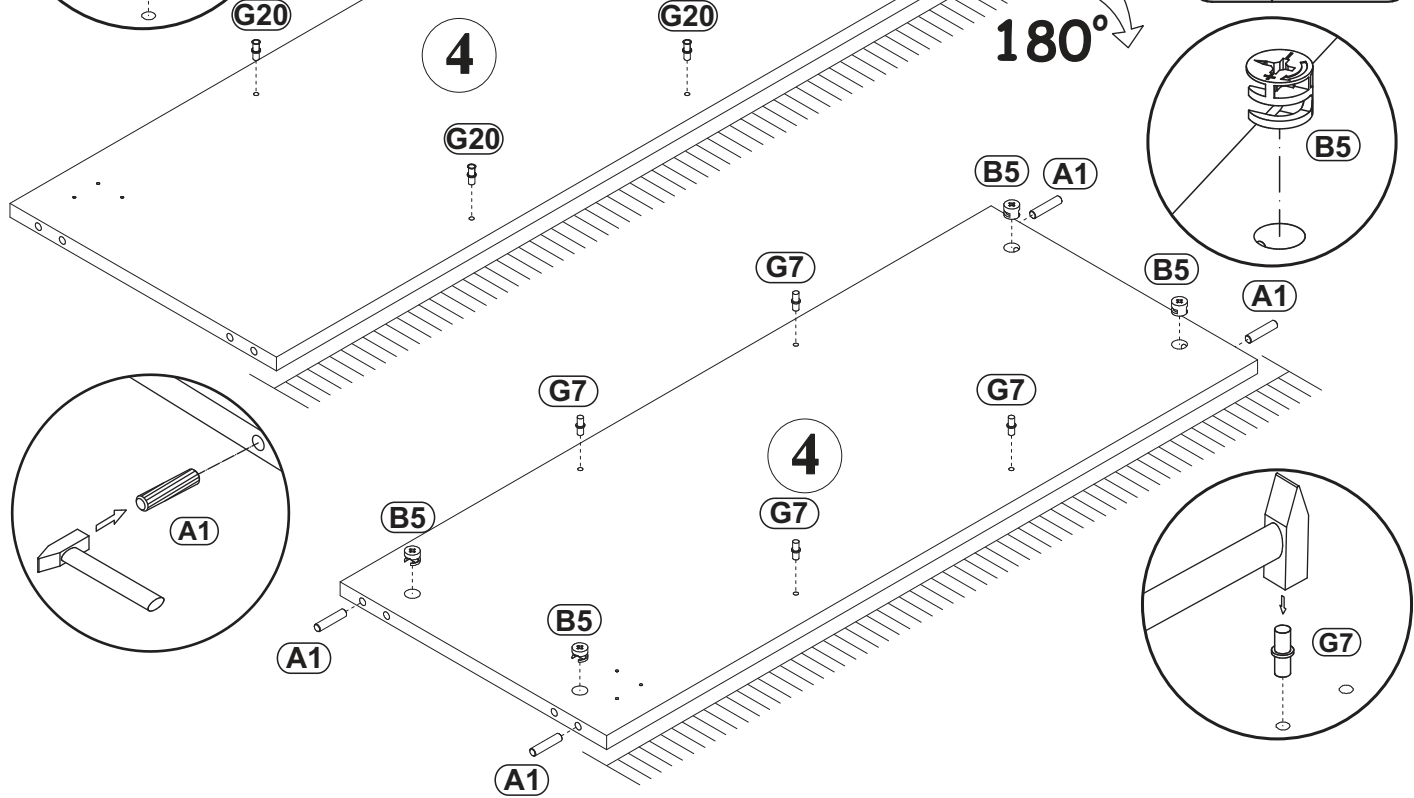
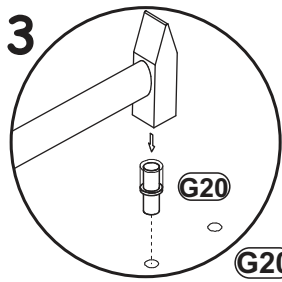

4

G2	
x1	

B11	
x8	Ø7x50

G4	
x8	

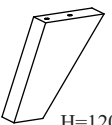
SK	
x4	H=120

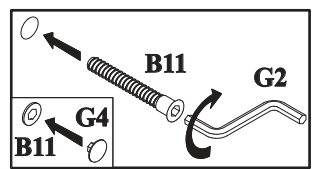
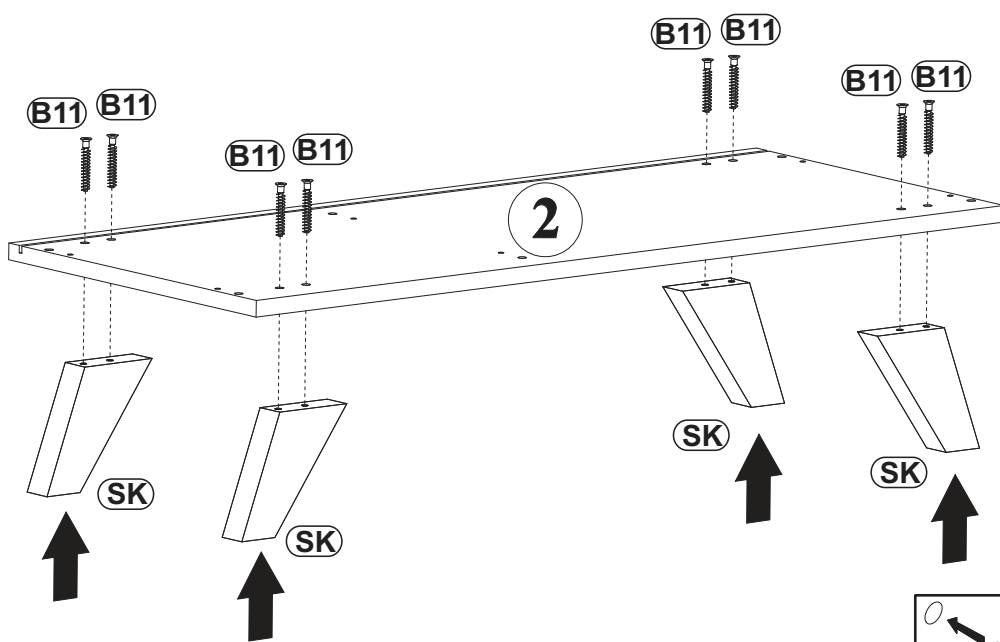

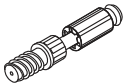
B4	
x6	

5

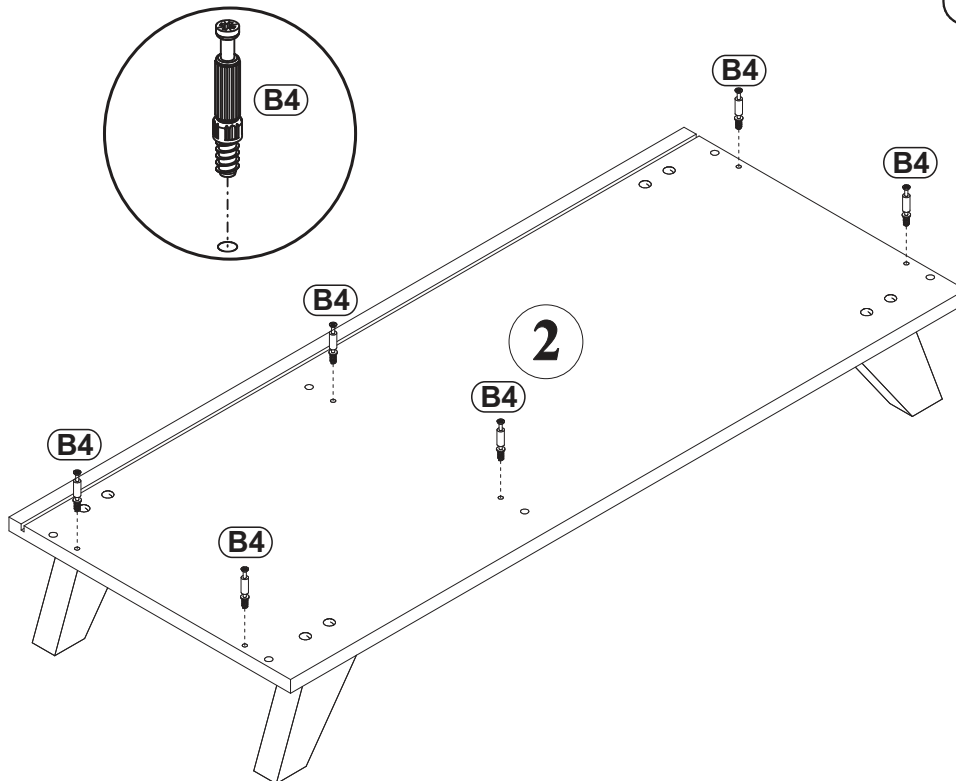

6

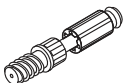
B4	
x6	

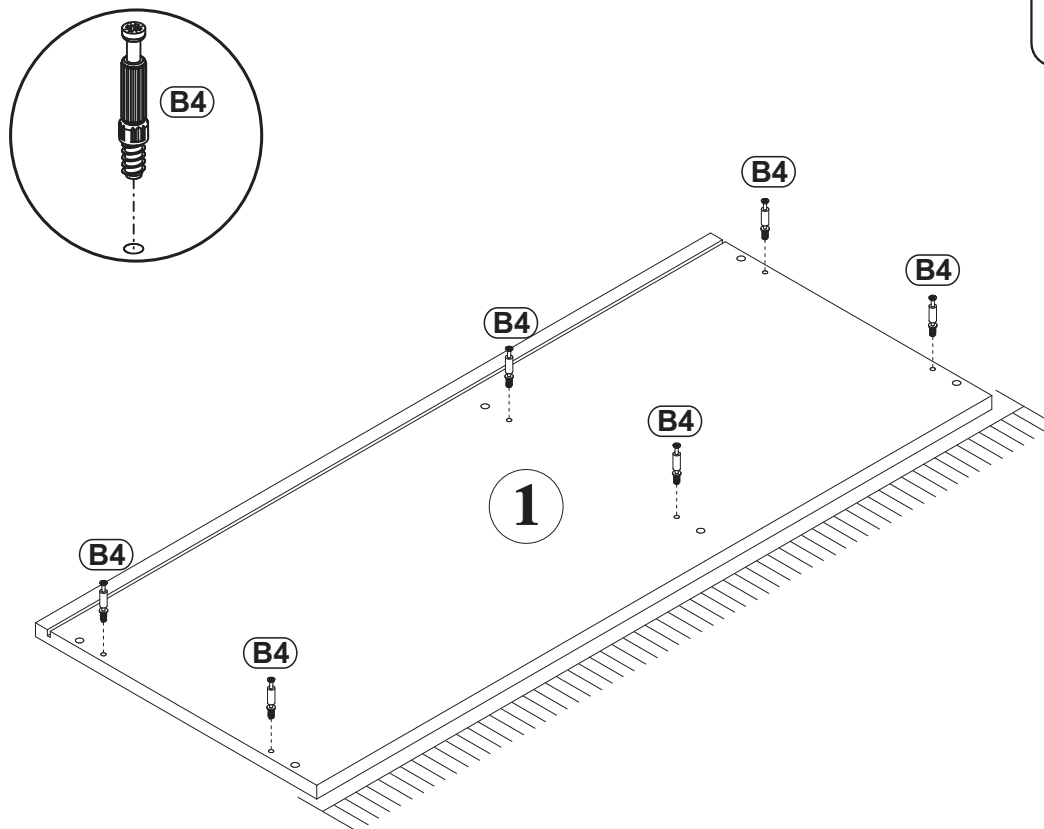

7

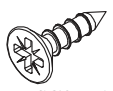
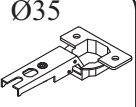
D10		E21	
x4	USØ3,5x13	x2	H=0

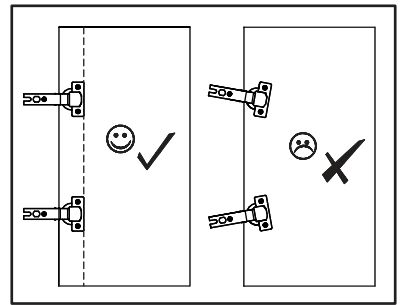
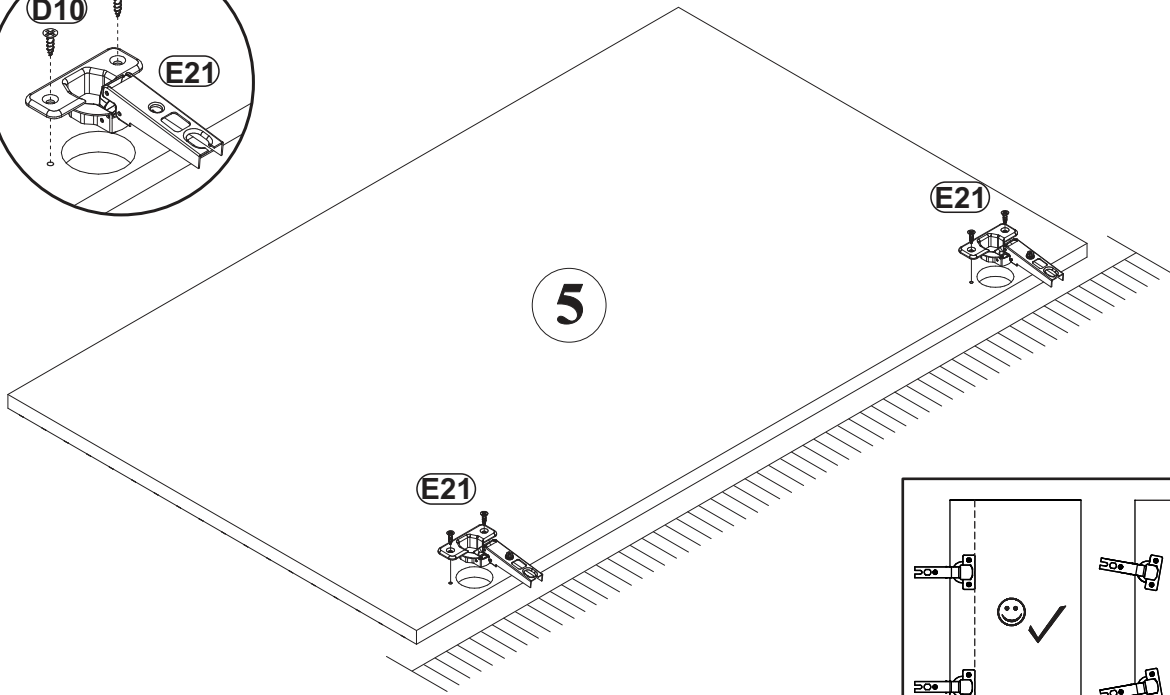
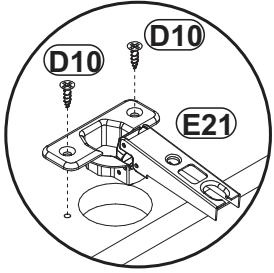

8

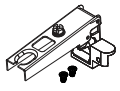
E38	
x2	H=0

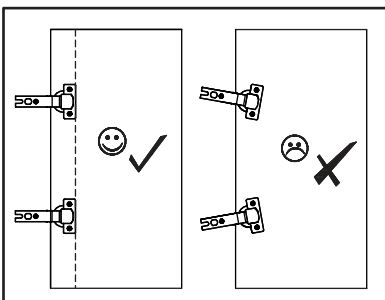
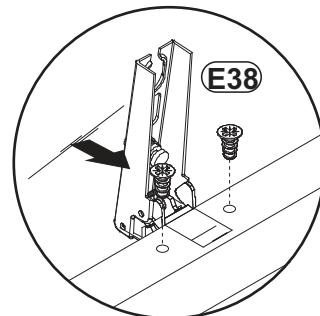
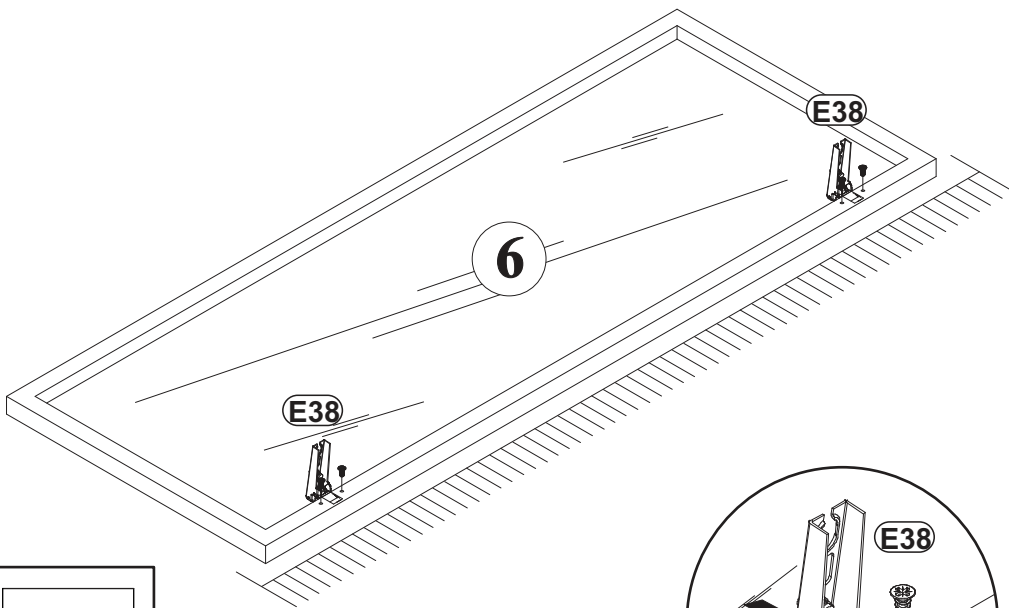

9

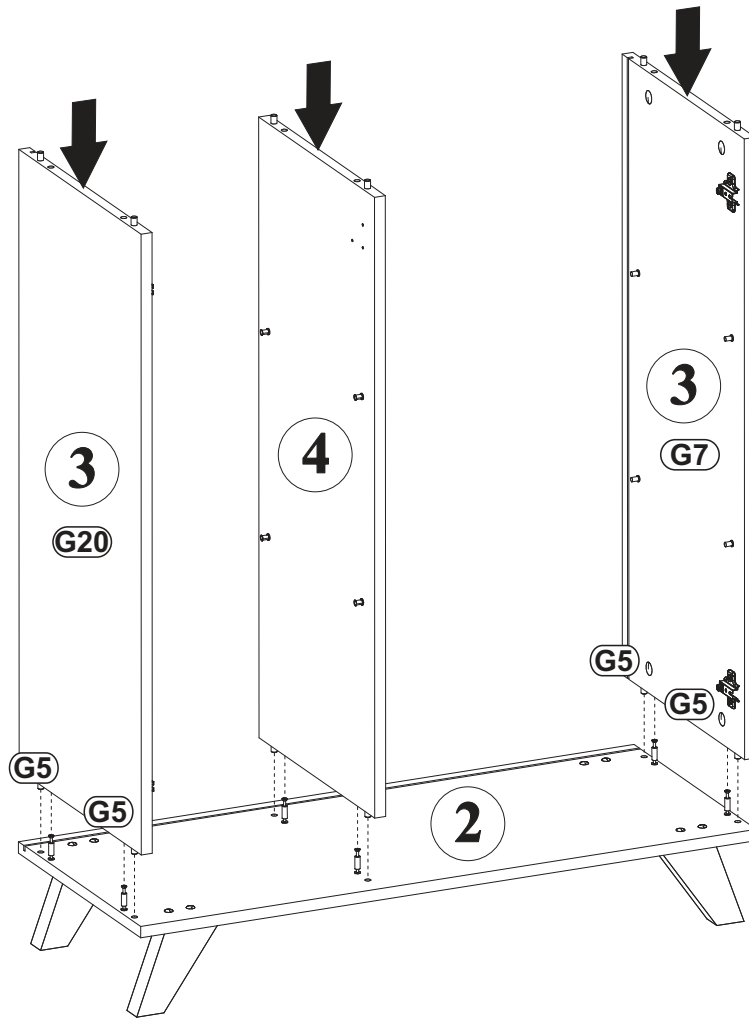
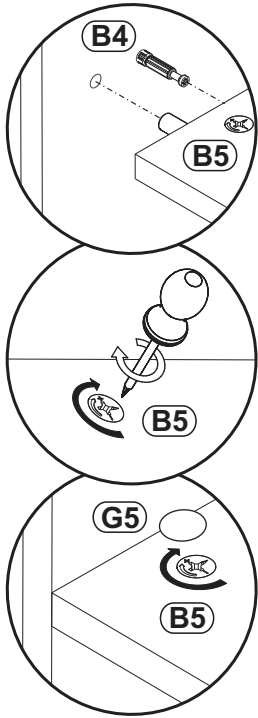

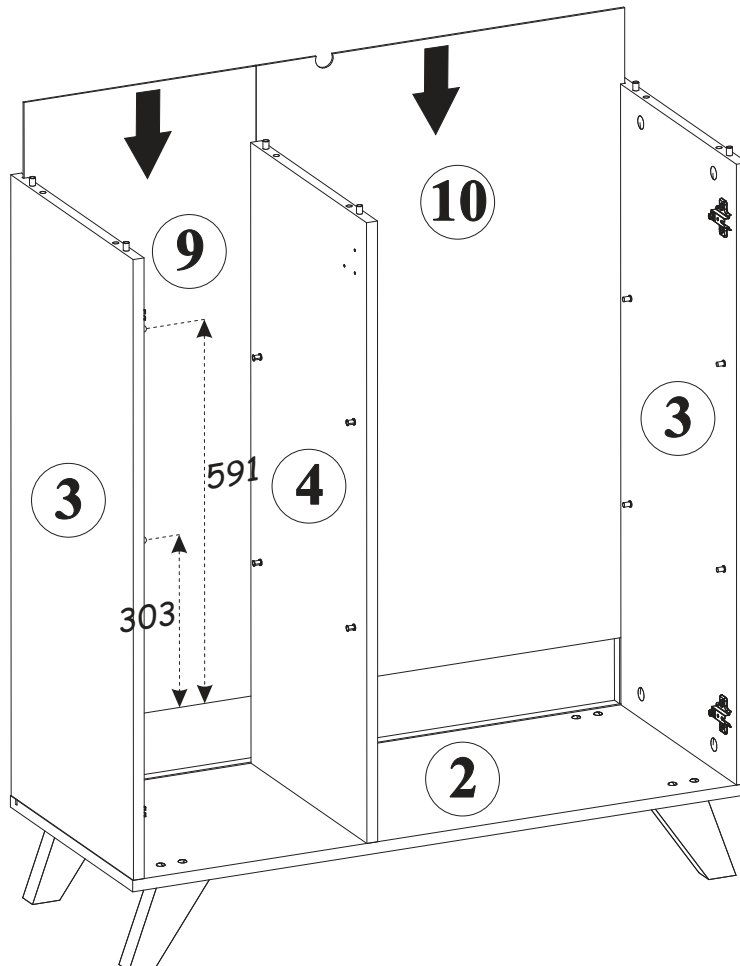

10

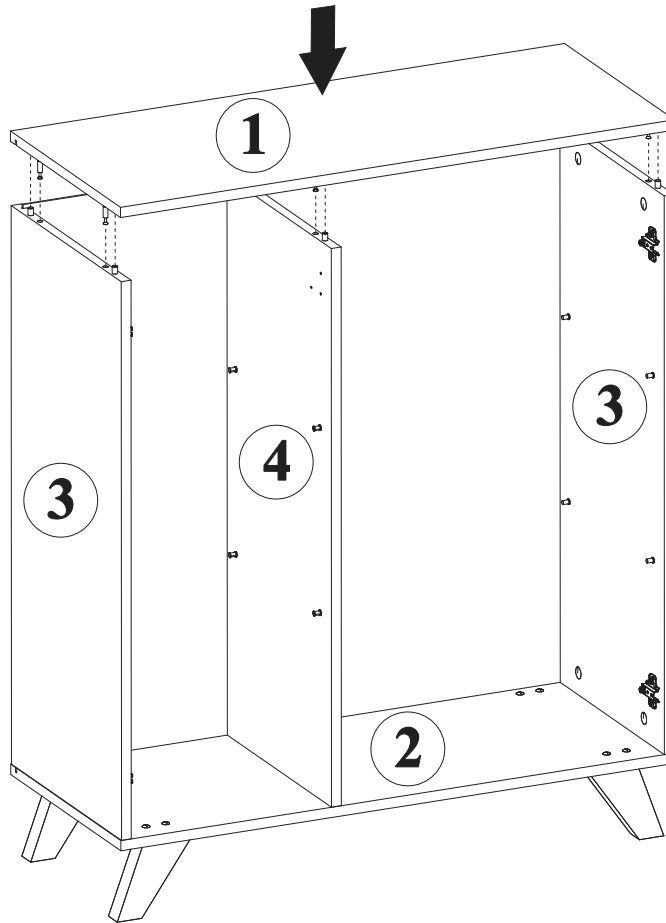

11



G5	
x6	

180° 

12

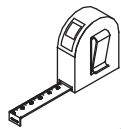

$X=Y$ 

UP13	
x6	UP03x16

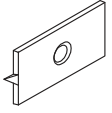
G16	
x6	

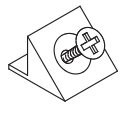
S1	
x16	

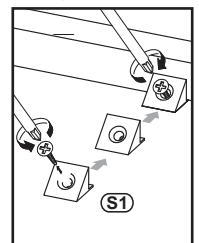
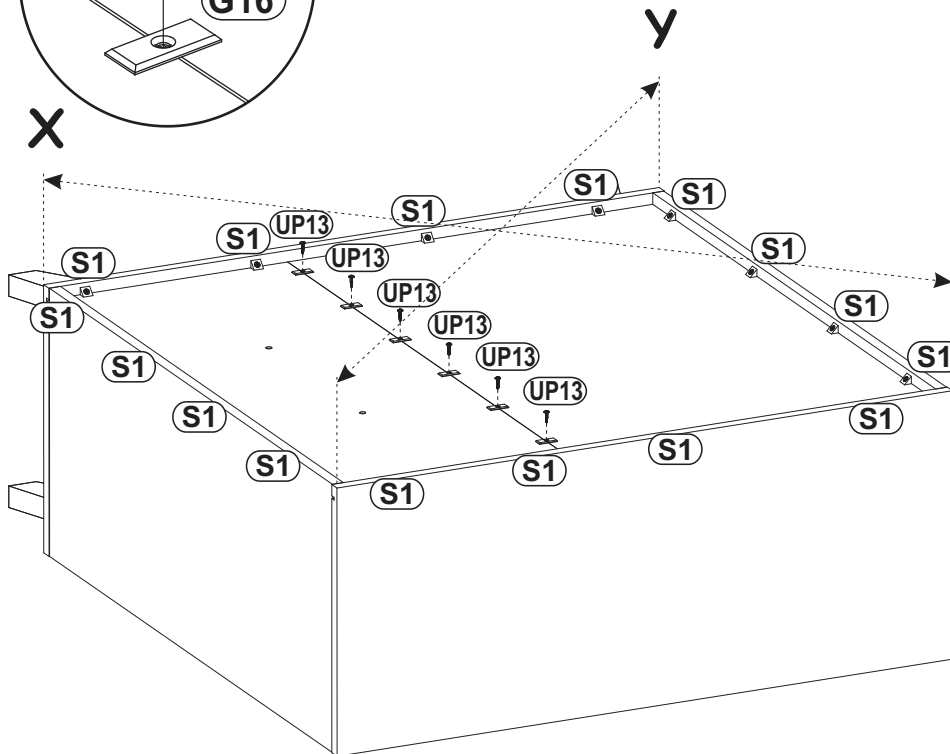
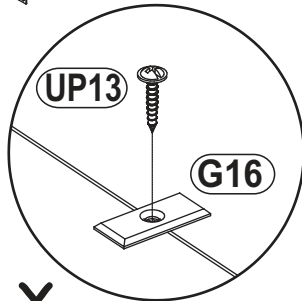

13

LED	
x1	1x2

D10	
x6	US03,5x13

KR1	
x1	Ø8

L1	
x1	

T3/T5	
x2	

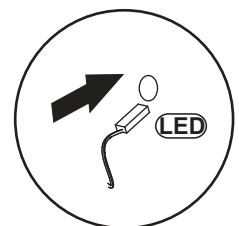
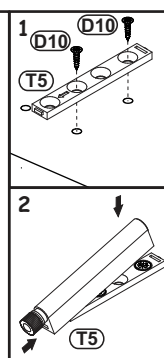
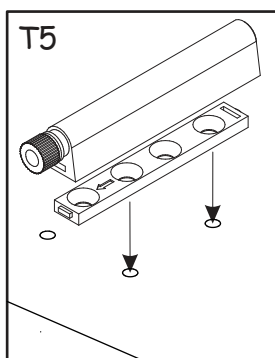
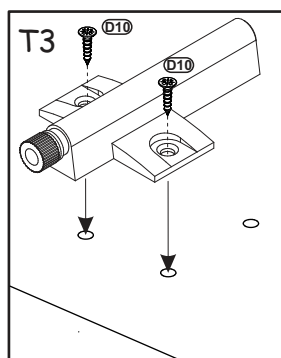
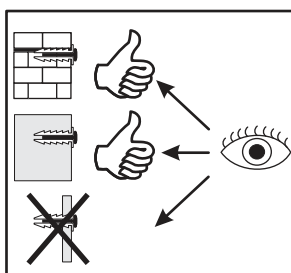
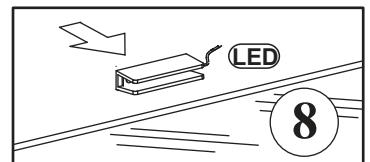
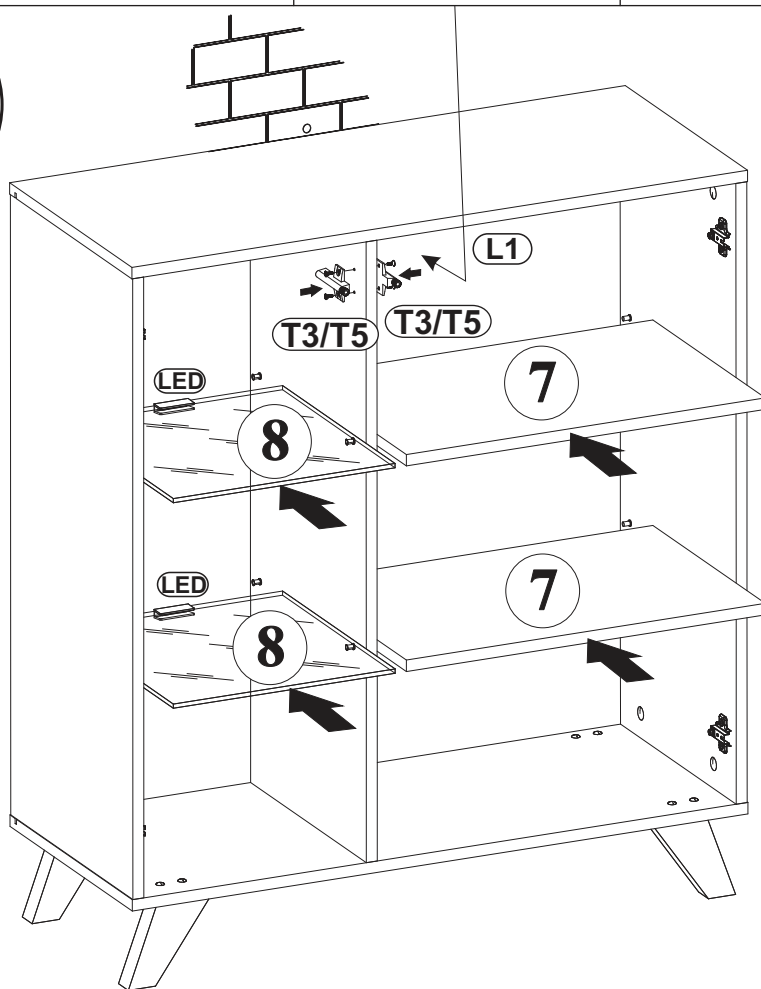
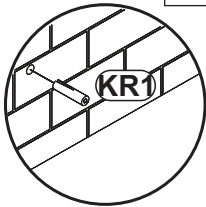
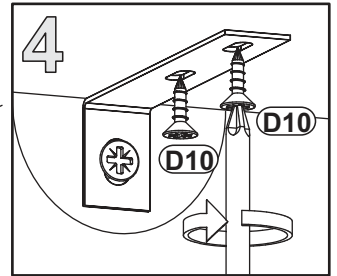
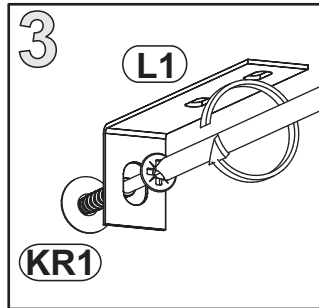
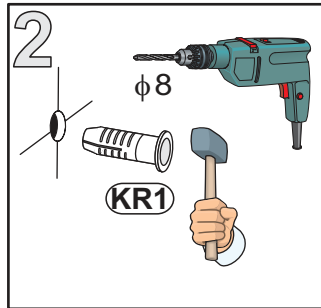
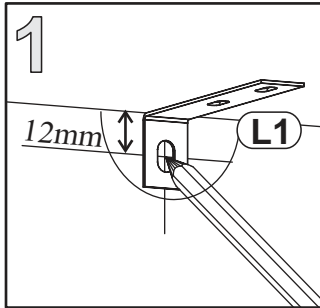

14

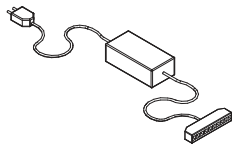

LED

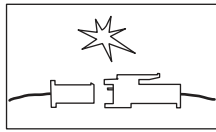

LED	
x1	